



GigaVUE-TA25E Hardware Installation Guide

GigaVUE TA Series

Product Version: 6.8

Document Version: 1.1

Last Updated: Friday, October 11, 2024

(See Change Notes for document updates.)

Copyright 2024 Gigamon Inc. All rights reserved.

Information in this document is subject to change without notice. The software described in this document is furnished under a license agreement or nondisclosure agreement. No part of this publication may be reproduced, transcribed, translated into any language, stored in a retrieval system, or transmitted in any form or any means without the written permission of Gigamon Inc.

Trademark Attributions

Gigamon and the Gigamon logo are trademarks of Gigamon in the United States and/or other countries. Gigamon trademarks can be found at www.gigamon.com/legal-trademarks. All other trademarks are the trademarks of their respective owners.

Gigamon Inc.
3300 Olcott Street
Santa Clara, CA 95054
408.831.4000

Change Notes

When a document is updated, the document version number on the cover page will indicate a new version and will provide a link to this Change Notes table, which will describe the updates.

| Product Version | Document Version | Date Updated | Change Notes |
|-----------------|------------------|--------------|--|
| 6.8 | 1.1 | 10/11/2024 | This update includes bug fixes and minor cosmetic changes for improved usability and document consistency. |
| 6.8 | 1.0 | 09/10/2024 | The original release of this document with 6.8 GA. |

Contents

| | |
|---|-----------|
| GigaVUE-TA25E Hardware Installation Guide | 1 |
| Change Notes | 3 |
| Contents | 4 |
| GigaVUE TA Series Overview | 6 |
| GigaVUE TA Series Nodes | 7 |
| GigaVUE TA Series Features and Benefits | 9 |
| Standard GigaVUE HC Series Features | 10 |
| Introducing the GigaVUE-TA25E Chassis | 11 |
| GigaVUE-TA25E Ports and Description | 12 |
| Quadrant Port Speed Limit | 13 |
| Chassis Cooling | 14 |
| Power LED | 17 |
| System LED | 17 |
| Fan LED | 17 |
| Port Status LEDs | 17 |
| PSU LEDs | 18 |
| GigaVUE-TA25E Rules and Notes | 18 |
| AMI_BIOS_Images | 19 |
| Air Flows Directions | 19 |
| AC and DC Powered GigaVUE-TA25E Models | 19 |
| Battery Caution | 19 |
| Breakout Modes | 20 |
| Configure the Port Mode | 20 |
| Breakout Panels | 21 |
| Getting Unpacked, Racked, Installed and Connected | 21 |
| Unpacking the GigaVUE TA Series Traffic Aggregator | 22 |
| Rack-Mounting the GigaVUE TA Series | 22 |
| Rack Mounting GigaVUE-TA25E | 23 |
| Attach the Brackets | 23 |
| Adjust Rear-Post Bracket Ears | 24 |
| Basic Connections and Configuration | 25 |
| Grounding the GigaVUE-TA25E | 25 |
| Connecting Power to GigaVUE-TA25E | 25 |
| Replacing Fans | 27 |

| | |
|--|-----------|
| Connecting Serial Console and Mgmt Ports | 27 |
| Port Licensing | 28 |
| GigaVUE-TA25EA | 28 |
| Enabling Additional Ports | 28 |
| Advanced feature licensing GigaVUE-TA25E | 30 |
| Command-Line Basics | 30 |
| Command-Line Modes | 30 |
| Entering Commands in the CLI | 31 |
| Command-Line Syntax – Entering Commands | 33 |
| Config Mode Syntax | 33 |
| Paging through CLI Output | 33 |
| The Basic Commands | 34 |
| Completing the Initial Setup | 37 |
| Enter the Configure Command-Line Mode | 37 |
| SSH2 | 37 |
| Advantages of SSH2 | 38 |
| Changing Host Keys | 39 |
| Initial User Account Configuration | 39 |
| Configuring the GigaVUE TA Series Host Name | 40 |
| Configuring GigaVUE TA Series Node’s Time Options | 41 |
| Setting Time Manually | 41 |
| Performing One-Time NTP Server Synchronization | 41 |
| Using NTP Time Server for System Clock Synchronization | 41 |
| Configuring Internet Explorer for Use with GigaVUE-FM | 42 |
| Configuring Automatic Email Notifications | 42 |
| Using a Custom Banner | 44 |
| Saving Changes | 45 |
| Connecting Ports on GigaVUE®TA Series | 45 |
| Transceiver—Rules and Notes | 45 |
| BiDi Optics Considerations | 46 |
| Transceiver Installation Instructions | 46 |
| MPO Cabling | 46 |
| MPO/MTP 12 Position Fiber Cable for Use with SR4 Transceivers | 47 |
| MTP/APC 12 Position Fiber Cable for Use with QSFP+ PLR4 Transceivers | 47 |
| MPO/MTP 24 Position Fiber Cable for Use with SR10 Transceivers | 48 |
| GigaVUE®TA Series Specifications | 48 |
| Physical Dimensions and Weight | 48 |
| Power Requirements | 49 |
| Fan Tray Specification for GigaVUE-TA25E | 49 |
| Environmental Specifications | 50 |
| Compliance GigaVUE-TA25E | 50 |
| Safety | 50 |

| | |
|--|-----------|
| Immunity | 50 |
| Emissions | 50 |
| Warranty | 51 |
| Regulatory Label GigaVUE-TA25E | 51 |
| Additional Sources of Information | 52 |
| Documentation | 52 |
| How to Download Software and Release Notes from My Gigamon | 54 |
| Documentation Feedback | 55 |
| Contact Technical Support | 56 |
| Contact Sales | 56 |
| Premium Support | 57 |
| The VUE Community | 57 |
| Glossary | 58 |

GigaVUE TA Series Overview



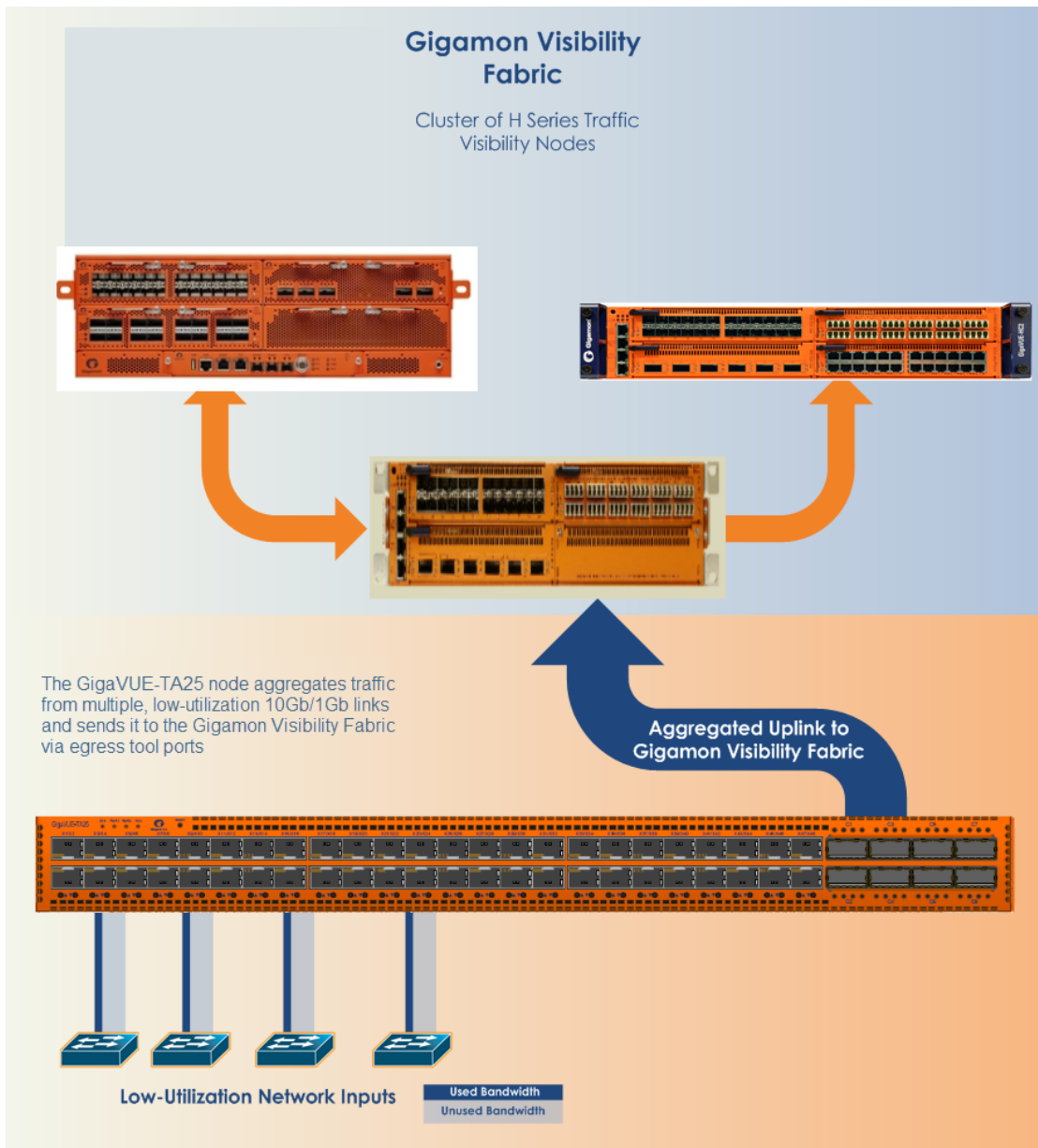

GigaVUE TA Series nodes allow you to aggregate the traffic from multiple low-utilization links before sending the traffic to the GigaVUE HC Series nodes that form your Gigamon Deep Observability Pipeline.

IMPORTANT: The GigaVUE TA Series support network, tool, clustering, and stack port connections to other GigaVUE TA Series nodes, including GigaVUE HC Series nodes.



GigaVUE TA Series Nodes

GigaVUE TA Series includes the following models:

| | | |
|-----------------------------|---|--|
| <p>GigaVUE-TA25</p> | <ul style="list-style-type: none"> ▪ 1RU Footprint ▪ 48 1Gb/10Gb/25Gb ports and 8 40Gb/100Gb ports, dual hot-pluggable power supplies (AC/DC), four rear hot-swappable fan modules, two console ports, and a 10M/100M/1Gb management port. ▪ Optional patch or breakout panel support ▪ Cluster with HC Series nodes |  |
| <p>GigaVUE-TA25E</p> | <ul style="list-style-type: none"> ▪ 1RU Footprint ▪ 48 1Gb/10Gb/25Gb ports and 8 40Gb/100Gb port, dual hot-pluggable power supplies (AC/DC), four rear hot-swappable fan modules, two console ports, and a 10M/100M/1Gb management port. ▪ Optional patch or breakout panel support ▪ Cluster with GigaVUE HC Series nodes |  |
| <p>GigaVUE-TA100</p> | <ul style="list-style-type: none"> ▪ 1RU Footprint ▪ 32 40Gb/100Gb ports, dual hot-pluggable power supplies (AC/DC), hot-swappable fan modules ▪ Optional patch or breakout panel support ▪ Cluster with GigaVUE HC Series nodes |  |
| <p>GigaVUE-TA200</p> | <ul style="list-style-type: none"> ▪ 2RU Footprint ▪ 64 40Gb/100Gb ports, dual hot-pluggable power supplies (AC/DC), hot-swappable fan modules ▪ Optional patch or breakout panel support ▪ Cluster with GigaVUE HC Series nodes |  |

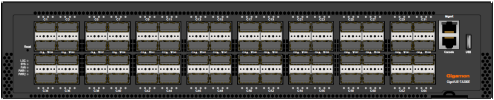
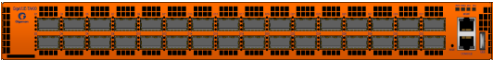
| | | |
|-----------------------|--|--|
| GigaVUE-TA200E | <ul style="list-style-type: none">▪ 2RU Footprint▪ 64 QSFP28 ports (40Gb/100Gb), dual hot-pluggable power supply modules (AC/DC) and hot-swappable fan modules.▪ UART RS232 Console port (RJ45) and Management port (RJ45). |  |
| GigaVUE-TA400 | <ul style="list-style-type: none">▪ 1RU Footprint▪ 32 40Gb/100Gb/400Gb QSFP-DD/ QSFP28/QSFP+ ports, dual hot-pluggable power supplies (AC/DC), seven rear hot-swappable fan modules, console port and a 10M/100M/1Gb management port.▪ Cluster with HC Series nodes |  |

GigaVUE TA Series Features and Benefits

GigaVUE TA Series nodes allow you to aggregate traffic from multiple network links from 1Gb up to 100Gb. The GigaVUE TA Series can pre-filter traffic for monitoring or be integrated into the GigaVUE HC Series cluster for end-to-end Flow Mapping® and management.

The GigaVUE HC Series and GigaVUE TA Series products share the same GigaVUE-OS software and are managed by GigaVUE-FM fabric manager for simplified operations. Traffic from any of these ports can be processed by GigaSMART traffic intelligence functions in GigaVUE HC Series devices to further optimize the traffic before it is sent to the tools.

GigaVUE TA Series nodes offer the following features and benefits:

- High-density visibility for 1Gb, 10Gb, 25Gb, 40Gb, 100Gb and 400Gb.
- Low profile 2RU for GigaVUE-TA200 and GigaVUE-TA200E design offers easy deployment at the top of the rack or end of a row in data centers.
- Depending on the model, the GigaVUE TA Series supports a wide variety of Gigamon® transceivers. Transceivers purchased from other vendors are not supported.

- Optional patch panel or breakout panel allows use of 40Gb ports as four individual 10Gb ports on all the GigaVUE TA Series nodes, or 100Gb ports as four individual 25Gb ports on GigaVUE-TA200, GigaVUE-TA200E, GigaVUE-TA25, GigaVUE-TA25E or 400Gb ports as four individual 100Gb ports on GigaVUE-TA400.
- All ports of the same type and speed can be used to create GigaStream.
- Front to back cooling.
- Fan modules.
- AC or DC power supply. Included with each node is the redundant second power supply.

Standard GigaVUE HC Series Features

In addition to the features described above, the GigaVUE TA Series offers many standard features from the GigaVUE HC Series nodes:

| Benefit | Descriptions |
|------------------------------|---|
| Remote Management | Configure the GigaVUE TA Series Traffic Aggregator's operations from a command-line interface: <ul style="list-style-type: none"> • Local access over the serial console port. • Remote network access using SSH2 over the 1000 Ethernet Mgmt port. • Secure access to the CLI, either through local authentication or optional RADIUS/TACACS+/LDAP support. • Powerful and flexible logging, including event notification via syslog, email, and SNMP traps. |
| Aggregate Links | Send the data from multiple different network ports to a tool port or GigaStream, allowing you to combine traffic from multiple access points into a single stream for uplink to the Gigamon Deep Observability Pipeline. |
| CLI Management | The GigaVUE TA Series nodes feature a common CLI with other GigaVUE HC Series nodes. |
| Command Abbreviation | Type only as many letters of a command as are needed to positively differentiate from other available commands. For example, you only need to type con t to enter Config mode, not the full configure terminal command. |
| SNMP Support | Rely on secure SNMP v3 access to the onboard SNMP agent as well as v1/v2 SNMP traps. |
| Email Notifications | Use email alerts for proactive notification of a wide variety of GigaVUE TA Series node events, helping you keep tabs on system status in real time. |
| Scalable Port Density | The GigaVUE-TA100 can have either sixteen (16), twenty-four (24), or thirty-two (32) 100Gb ports enabled. Licenses are available for the additional two sets of 8 ports. The GigaVUE-TA200 can have either thirty-two (32) or sixty-four (64) 100Gb ports enabled. A license is available for the additional 32 ports. The GigaVUE-TA200E can have either thirty-two (32) or sixty-four |

| Benefit | Descriptions |
|---|---|
| | <p>(64) 100Gb/40Gb ports. A license is available for the additional 32 ports.</p> <p>The GigaVUE-TA25 has forty-eight (48) 25Gb/10Gb/1Gb ports and eight (8) 100Gb/40Gb ports enabled.</p> <p>A 24-port GigaVUE-TA25 called the GigaVUE-TA25A is also available. License is required to upgrade the GigaVUE-TA25A to include all 48 25Gb/10Gb/1Gb ports and the eight (8) 100Gb/40Gb ports .</p> <p>The GigaVUE-TA25E has forty-eight (48) 25Gb/10Gb/1Gb ports and eight (8) 100Gb/40Gb ports enabled.</p> <p>A 24-port GigaVUE-TA25E called the GigaVUE-TA25EA is also available. License is required to upgrade the GigaVUE-TA25EA to include all forty-eight (48) 25Gb/10Gb/1Gb ports as well as the eight (8) 100Gb/40Gb ports.</p> <p>The GigaVUE-TA400 has 32 400Gb/100Gb/40Gb QSFP-DD/QSFP28/QSFP+ ports and seven rear hot-swappable fan modules, a console port, and a 10M/100M/1Gb management port.</p> <p>The GigaVUE TA Series nodes make it easy to leverage the system’s high port density, aggregating multiple underused 400Gb/100Gb/40Gb/25Gb/10Gb/1Gb network ports to 400Gb/100Gb/40Gb/25Gb/10Gb/1Gb tool ports for uplink to the Gigamon Deep Observability Pipeline.</p> |
| Clustering | <p>The GigaVUE-TA100, GigaVUE-TA200, GigaVUE-TA200E nodes, GigaVUE-TA25 , GigaVUE-TA25E, and GigaVUE-TA400 can cluster with other GigaVUE HC Series nodes.</p> <p>The GigaVUE-TA400 can cluster with all GigaVUE HC Series nodes and GigaVUE TA Series nodes only with E-tag mode.</p> <p>This allows you to take advantage of features such as GigaSMART.</p> |
| Ingress VLAN Tagging | <p>VLAN Tags can be added to the ingress packets on a per-port basis. This can help identify, differentiate, or track incoming sources of traffic.</p> |
| GigaVUE-FM (Centralized Management System) | <p>Use the centralized GigaVUE TA Series Fabric Management System to review, configure, and update GigaVUE TA Series just like other GigaVUE HC Series.</p> |

Introducing the GigaVUE-TA25E Chassis

The GigaVUE-TA25E chassis consists of a 1RU, rack-mountable, 17" wide chassis with network, tool, management, and console ports at the front and power connections and fan module at the rear. Refer to [GigaVUE-TA25E Ports and Description](#) for a description of each of the port.

Figure 1 *Front View*

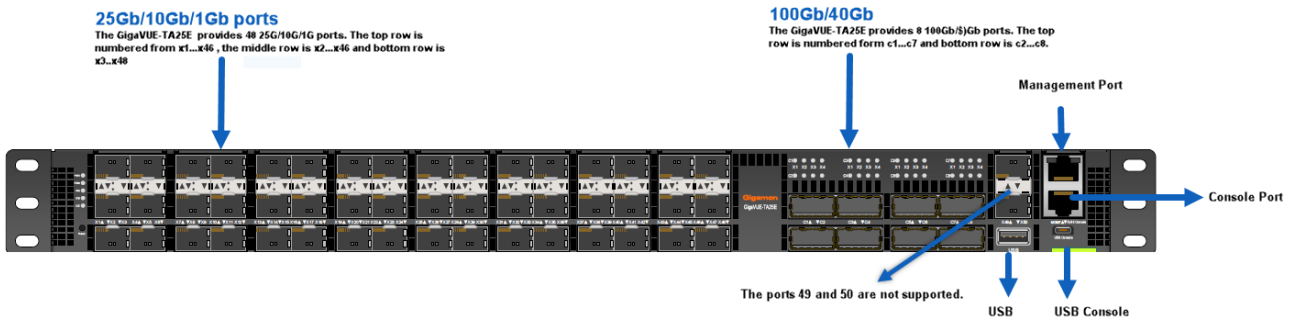
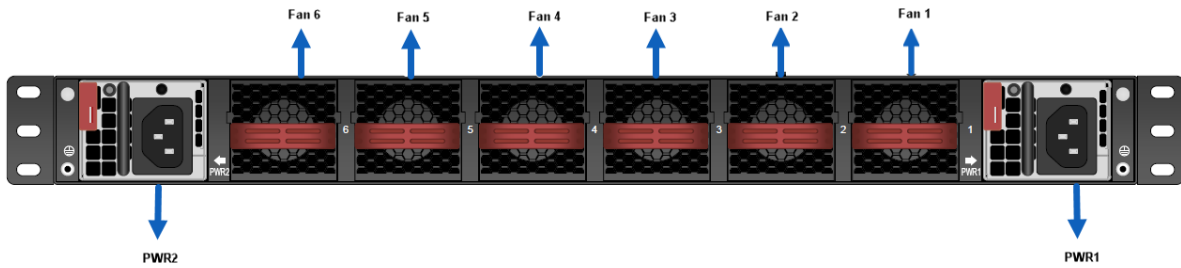

Figure 2 Rear View



GigaVUE-TA25E Ports and Description

| Port | Description |
|-----------------------|---|
| Management | Use the Mgmt port for remote configuration of the GigaVUE-TA25E Traffic Aggregator over a 1000 Ethernet network. Refer to the installation guide for information on establishing an SSH configuration session with the GigaVUE-TA25E Traffic Aggregator. |
| Console | Use the Console port for local configuration of the GigaVUE-TA25E Traffic Aggregator over a serial connection. The serial settings are 8N1,115,200 bps. Refer to installation guide for information on establishing a serial configuration session with the GigaVUE-TA25E Traffic Aggregator in a terminal window. |
| USB Console | The USB Console is an alternative of RJ45 console port that would allow you to access GigaVUE-TA25E. |
| Ports x1...x48 | The GigaVUE-TA25E provides 48 25Gb/10Gb/1Gb ports (x1..x48). For details about the supported transceivers and cable type, refer to the “GigaVUE Interoperability Matrix”. The 24-port GigaVUE-TA25E is called GigaVUE-TA25EA. Refer to the Port Licensing section for license information to expand the 24-port GigaVUE-TA25EA to 48 25Gb/10Gb/1Gb ports and to enable eight 100Gb/40Gb ports. |
| Ports c1...c8 | GigaVUE-TA25E also includes 8 100Gb/40Gb ports (c1..c8). |

| Port | Description |
|------------------------|--|
| Ports x49...x50 | The GigaVUE-TA25E chassis provides two additional 10Gb ports (x49...x50) on the right side that are not yet supported. |
| Pseudo-Slots | GigaVUE-TA25E supports two pseudo-slots. The mapping of pseudo-slots is as follows: Pseudo-slot 1 – 1/1/x1..x39, x42 Pseudo-slot 2 – 1/1/x40...41, 1/1/x43.....x48, 1/1/c1..c8 To view the CLI output above, use the command <code>show pseudo-slot portmap box-id</code> |
| Reset Button | This button on the front panel next to Gigamon logo allows you to reset GigaVUE-TA25E without having to unplug both PSU's. Push and hold the button for 5 seconds to reset. |
| Transceivers | For details about the supported transceivers and cable type, refer to the GigaVUE-OS Compatibility and Interoperability Matrix |

Quadrant Port Speed Limit

The GigaVUE-TA25E ports follow a Quadrant port speed limit. The grouping is as shown in below figure:

| | | | | | | | | | | | | | | | |
|----|----|----|-----|-----|-----|-----|-----|-----|-----|-----|-----|-----|-----|-----|-----|
| x1 | x4 | x7 | x10 | x13 | x16 | x19 | x22 | x25 | x28 | x31 | x34 | x37 | x40 | x43 | x46 |
| x2 | x5 | x8 | x11 | x14 | x17 | x20 | x23 | x26 | x29 | x32 | x35 | x38 | x41 | x44 | x47 |
| x3 | x6 | x9 | x12 | x15 | x18 | x21 | x24 | x27 | x30 | x33 | x36 | x39 | x42 | x45 | x48 |

The quadrant ports can be categorized into speed port groups, such as :

- Speed Group 1- x1,x2,x3,x6
- Speed Group 2- x4,x5,x7,x9
- Speed Group 3- x8,x10,x11,x12
- Speed Group 4- x13,x14,x15,x18
- Speed Group 5- x16,x17,x19,x21
- Speed Group 6- x20,x22,x23,x24
- Speed Group 7- x25,x26,x27,x30
- Speed Group 8- x28,x29,x31,x33
- Speed Group 9- x32,x34,x35,x36
- Speed Group 10- x37,x38,x39,x42
- Speed Group 11- x40,x41,x43,x45
- Speed Group 12- x44,x46,x47,x48

Each port in the quadrant speed group will follow the same speed that is being configured . For example , if the port x1 is configured with 25G speed then the other ports in the quadrant x2,x3,x6 should be configured with the same speed. In one quad group , there cannot be a mix of 10Gb and 25Gb ports.

To view the CLI output utilize the command `show gmon speed-port-group`

```
TA25E (config) # show gmon speed-port-group
=====
SpeedPortGroup          Port list
-----
SPG1                    x1, x2, x3, x6
SPG2                    x4, x5, x7, x9
SPG3                    x8, x10, x11, x12
SPG4                    x13, x14, x15, x18
SPG5                    x16, x17, x19, x21
SPG6                    x20, x22, x23, x24
SPG7                    x25, x26, x27, x30
SPG8                    x28, x29, x31, x33
SPG9                    x32, x34, x35, x36
SPG10                   x37, x38, x39, x42
SPG11                   x40, x41, x43, x45
SPG12                   x44, x46, x47, x48
=====
```



To view the same in GigaVUE-FM, on the left navigation pane, click , and then select **Physical>Nodes. >System> Chassis**. Select **Box Level Configuration > Speed Port Group** the speed groups would list as shown below.

| Speed Port Group | Ports List |
|------------------|--------------------|
| Group 1 | x1, x2, x3, x6 |
| Group 2 | x4, x5, x7, x9 |
| Group 3 | x8, x10, x11, x12 |
| Group 4 | x13, x14, x15, x18 |
| Group 5 | x16, x17, x19, x21 |
| Group 6 | x20, x22, x23, x24 |
| Group 7 | x25, x26, x27, x30 |
| Group 8 | x28, x29, x31, x33 |
| Group 9 | x32, x34, x35, x36 |
| Group 10 | x37, x38, x39, x42 |
| Group 11 | x40, x41, x43, x45 |
| Group 12 | x44, x46, x47, x48 |

Chassis Cooling

The fans on the GigaVUE-TA25E run at 100% of their maximum speed on power up, then drop to approximately 60% during normal operations. The temperatures of four components: transceivers, exhaust, CPU, and switch CPU, are monitored. When a

component crosses a pre-defined threshold, the fan speed is adjusted dynamically, in increments of approximately 10%. An SNMP trap is sent when a component reaches the threshold for warning or critical temperature conditions. Refer to [Component Temperature Thresholds and Actions](#) for the temperatures at which the warning and critical traps are sent and any additional action that occurs at a threshold.

Table 1: Component Temperature Thresholds and Actions

| CPU Temperature | Switch Board 1 Temperature | Switch Board 3 Temperature |
|--------------------|--|--|
| 90°C | 60°C | 50°C |
| Warning trap sent | Warning trap sent | Warning trap sent |
| 100°C | 65°C | 55°C |
| Alert trap sent | Alert trap sent; Switch CPU put in reset | Alert trap sent; Switch CPU put in reset |
| 105°C | 70°C | 60°C |
| Critical trap sent | Critical trap sent | Critical trap sent |

The output of the following CLI command displays the current exhaust, CPU, switch CPU temperatures, intake temperature as well as the fan speed in RPM :

```

gigamon-6db79d # show environment type fan
*** Box 1 (TA25E-Chassis) ***
-----
Fan tray 1 (TA25E-FANTRAY):
1st fan                : 8800 RPM
2nd fan                : 9300 RPM
-----
Fan tray 2 (TA25E-FANTRAY):
1st fan                : 8800 RPM
2nd fan                : 9000 RPM
-----
Fan tray 3 (TA25E-FANTRAY):
1st fan                : 8800 RPM
2nd fan                : 9100 RPM
-----
Fan tray 4 (TA25E-FANTRAY):
1st fan                : 9000 RPM
2nd fan                : 9200 RPM
-----
Fan tray 5 (TA25E-FANTRAY):
1st fan                : 8900 RPM
2nd fan                : 9100 RPM
-----
Fan tray 6 (TA25E-FANTRAY):
1st fan                : 8900 RPM
2nd fan                : 8900 RPM
=====
    
```

```

gigamon-6db79d # show environment type psu psu-detail all
*** Box 1 (TA25E-Chassis) ***
-----
Power Module 1 (TA25E-PWR-AC):
Product Code           : FSF019
Serial Num            : FSF019214300550
HW Rev                : 02
Status                : off
ac_or_dc              : N/A
input_voltage(V)      : 0.000
input_current(A)      : 0.000
output_voltage(V)     : 0.000
output_current(A)     : 0.000
temperature_1(C)      : 0.000
temperature_2(C)      : 0.000
temperature_3(C)      : 0.000
psu_fan_speed(RPM)    : 0
output_power(W)       : 0.000
input_power(W)        : 0.000
busy_fault            : ok
off_fault             : ok
output_over_voltage_fault : ok
output_over_current_fault : ok
input_under_voltage_fault : ok
input_over_voltage_fault : ok
temperature_fault     : ok
communication_fault   : ok
-----
Power Module 2 (TA25E-PWR-AC):
Product Code           : FSF019
Serial Num            : FSF019214300551
HW Rev                : 02
Status                : on
ac_or_dc              : AC
input_voltage(V)      : 208.500
input_current(A)      : 0.625
output_voltage(V)     : 12.125
output_current(A)     : 10.500
temperature_1(C)      : 41.000
temperature_2(C)      : 39.000
temperature_3(C)      : 30.000
psu_fan_speed(RPM)    : 6272
output_power(W)       : 133.000
input_power(W)        : 136.000
busy_fault            : ok
off_fault             : ok
output_over_voltage_fault : ok
output_over_current_fault : ok
input_under_voltage_fault : ok
input_over_voltage_fault : ok
temperature_fault     : ok
communication_fault   : ok
=====

```

The GigaVUE-FM screen would display the current exhaust, CPU, switch CPU temperatures, intake temperature as well as the fan speed in RPM as shown below:

The screenshot shows the 'TA25E > Chassis' configuration page. The left sidebar contains navigation options: Overview, Health, Save Config..., SYSTEM (Chassis, Ports, GigaSMART, Inline Bypass), TRAFFIC (Maps), SETTINGS (Settings, Roles and...), and SUPPORT (Logs, Debug, About). The main content area is titled 'Box ID 1 - TA25E' and features a 'FAN TRAYS' table with columns: Fan Tray Id, Hardware Type, Status, Hardware Revision, Product Code, and Serial Number. Below this is a 'FAN RPM' table with columns: Fan Tray Id, 1st, and 2nd. Both tables include pagination controls and a 'Total Records: 6' indicator.

| Fan Tray Id | Hardware Type | Status | Hardware Revision | Product Code | Serial Number |
|-------------|---------------|--------|-------------------|--------------|---------------|
| 1 | FAN-TAX20E | ✓ | | | |
| 2 | FAN-TAX20E | ✓ | | | |
| 3 | FAN-TAX20E | ✓ | | | |
| 4 | FAN-TAX20E | ✓ | | | |

| Fan Tray Id | 1st | 2nd |
|-------------|----------|----------|
| 1 | 9100 RPM | 9400 RPM |
| 2 | 9100 RPM | 9400 RPM |
| 3 | 8800 RPM | 8900 RPM |
| 4 | 9000 RPM | 9300 RPM |

Power LED

The power LEDs on the front of the chassis (PWR1 and PWR2) are as follows:

- Solid GREEN indicates that the power supply unit (PSU) is connected to switch and is operating normally.
- Off indicates that the PSU is disconnected.

System LED

The system LED on the front of the chassis is as follows:

- Solid GREEN indicates normal operation
- Solid AMBER indicates system failure.
- Off indicates no power

Fan LED

The fan LED on the chassis is as follows:

- Solid GREEN indicates all fans are operating normally.
- Solid RED indicates fan has failed and fan tray is missing

Port Status LEDs

The Port LED for GigaVUE-TA25E operates as follows:

The QSFP28 Port status are as follows:

- GREEN indicates the port has a valid link at 100G.
- BLUE indicates the port has a valid link at 40G.
- YELLOW indicates the port has a valid link at 4x 25G.
- PURPLE indicates the port has a valid link at 4x 10G.
- Off indicates the link is operationally down.

The SFP28 Port status are as follows:

- GREEN indicates the port has a valid link at 25G.
- YELLOW indicates the port has a valid link at 10G.
- OFF indicates the link is operationally down.

PSU LEDs

The individual power LEDs on the rear of the chassis are as follows:

- GREEN indicates the PSU is operating normally and is receiving good AC input.
- OFF indicates the PSU is not operational and is not receiving any AC input.

GigaVUE-TA25E Rules and Notes

Keep in mind the following rules and notes when using the GigaVUE-TA25E:

| GigaVUE-TA25E Rules and Notes | |
|------------------------------------|---|
| Transceivers | All Gigamon labeled 1Gb, 10Gb, 25Gb, 40Gb and 100Gb optics are supported. For details about the supported transceiver, cable type, and connectivity specifications, refer to " GigaVUE-OS Compatibility and Interoperability Matrix ". |
| Network, Tool, Hybrid, Stack Port. | The GigaVUE-TA25E all ports can be used as network, tool, hybrid, circuit, and stack-link in all speeds. |
| Map Rules and Port Filters | The GigaVUE-TA25E supports 256 map rules per pseudo slot and 20 egress port filters per pseudo slot, without advanced feature license. For details about the maximum map rule with advanced feature license, refer to the "Maximum Map Rules" table in the GigaVUE Fabric Management Guide. |
| Inline Bypass Feature | Starting from software release 6.7 version, GigaVUE-TA25E supports Inline Bypass feature. |
| Port Licensing | On the GigaVUE-TA25E, all ports are enabled. For the GigaVUE-TA25EA, upgrading with a port license will enable additional ports. Refer to Port Licensing section for more information. |
| Cluster Licensing | Connecting a GigaVUE-TA25E to a cluster requires the Advanced Features License. |

AMI_BIOS_Images

The GigaVUE-TA25E has an AMI Basic Input/Output System (BIOS). The BIOS image is packaged with the software image. The BIOS contents are stored in flash memory, allowing the BIOS to be upgraded. There are two flash components, a primary and a secondary.

The following CLI command displays the two flash components and indicates the BIOS image from which the system booted using asterisks:

```
gigamon-6db79d # show ver
Product name:      GigaVUE-OS
Product release:  6.0.00_Beta
Build ID:         338074_Debug
Build date:       2022-07-14 16:55:38
Target arch:      x86_64
Target OS:        linux_el_el7
Target hw:        gvta25e
Built by:         root@jenkins-slave535
Git full hash:    b331be222d333a584a6ed7d41a9dd3e35a50679a
Version summary:  GigaVUE-OS 6.0.00_Beta Build 338074_Debug 2022-07-14 16:55:38 x86_64 gvta25e root@jenkins-slave535:git:b331be222d33

CPU CPLD version: 0x0f
SW CPLD1 version: 0x02
SW CPLD2 version: 0x03
SW CPLD3 version: 0x02
FAN CPLD version: 0xd3

1st flash version: v40.01.01.00
2nd flash version: v40.01.01.00 **

Product model:    GigaVUE-TA25E
Product hw:       gvta25e
Host ID:          dca2ff0ef2ab
System UUID:      dca2ff0e-2abd-a2ff-ef2ab-ca2ff0ef2ab

Uptime:          14m 5.730s
CPU load averages: 0.01 / 0.06 / 0.10 (1m/5m/15m)
Number of CPUs:  8
System memory:   698 MB used / 15181 MB free / 15879 MB total
Swap:            0 MB used / 0 MB free / 0 MB total
gigamon-6db79d #
```

If there is a component failure in the primary flash, the GigaVUE-TA25E boots from a backup golden BIOS image in the secondary flash. An SNMP trap can be configured to be sent when the system has booted from the secondary flash. The trap may indicate that the primary flash component needs to be serviced. The trap is as follows:

Air Flows Directions

The air flow direction is from the front of the GigaVUE-TA25E chassis to the rear. The rear-mounted fans pull air from the front to the back of the chassis. For environments with hot/cold aisles, install the chassis so the intake air at the front of the chassis is cold.

AC and DC Powered GigaVUE-TA25E Models

Gigamon provides both AC and DC-powered versions of the GigaVUE-TA25E. Refer to [Connecting Power to GigaVUE-TA25E](#).

Battery Caution

A disposable, non-rechargeable, Real Time Clock (RTC) Lithium manganese dioxide button battery is in the GigaVUE-TA25E. Note the following:

- There is a risk of fire if the battery is replaced with an incorrect type.
- Use only CR1220 type Lithium manganese dioxide button battery and replace with the same.

Breakout Modes

The breakout modes for GigaVUE TA Series can be in port mode. GigaVUE-TA25, GigaVUE-TA25E, GigaVUE-TA100, GigaVUE-TA200, GigaVUE-TA200E and GigaVUE-TA400 allows port breakout mode. Refer to the [Configure the Port Mode](#) for further details.

Configure the Port Mode

The port breakout modes are as follows:

- **4x10Gb**—Specifies the **4x10Gb** port breakout mode. This mode applies to GigaVUE-TA100, GigaVUE-TA200, GigaVUE-TA200E, GigaVUE-TA25, GigaVUE-TA25E and GigaVUE-TA400. This mode provides a 4 x 10Gb breakout option for 40Gb ports.
- **4x25Gb**—Specifies the **4x25Gb** port breakout mode. This mode applies to GigaVUE-TA200, GigaVUE-TA200E, GigaVUE-TA25, GigaVUE-TA25E and GigaVUE-TA400 nodes. This mode provides a 4 x 25Gb breakout option for 100Gb ports.
- **4x100Gb**—Specifies 4x100Gb port breakout mode. This mode applies to GigaVUE-TA400 nodes. This mode provides a 4x100Gb breakout option for 400Gb ports
- **none**—Specifies no port breakout mode. This is the default mode for GigaVUE TA Series nodes.

Any of the 100Gb ports on the GigaVUE-TA100 (1/1/c1 to 1/1/c32), the first 32 ports on the GigaVUE-TA200 and GigaVUE-TA200E (1/1/c1 to 1/1/c32), the eight ports on GigaVUE-TA25 (1/1/c1..1/1/c8) or any ports in GigaVUE-TA400 can operate at 40Gb with QSFP+ SR transceivers.

A 40Gb port can be broken out into four 10Gb ports, called subports. In GigaVUE-TA25 only the ports c1 and c5 support 4 x10G breakout mode. The subports will all have the same speed (10Gb). Subports will have x1 to x4 appended to their port ID, for example, when port 1/1/c2 on GigaVUE-TA100 is configured to 4x10G mode, the subports will be: 1/1/c2x1, 1/1/c2x2, 1/1/c2x3, and 1/1/c2x4.

In **4x10Gb** mode, the subports can function as network, tool, stack, circuit and hybrid ports. GigaStream port members can be activated in the tool, stack, and hybrid port types. Subports on GigaVUE-TA100, GigaVUE-TA200, GigaVUE-TA200E and GigaVUE-TA400 can also function as stack ports.

- The maximum number of 10Gb subports on a GigaVUE-TA100 is 128 (32 x 4).
- The maximum number of 10Gb subports on a GigaVUE-TA200 and GigaVUE-TA200E is 128 (32 x 4).
- The maximum number of 10Gb subports on GigaVUE-TA25 is 8 (2 x 4)

- The maximum number of 10Gb subports on GigaVUE-TA25E is 32 (8x 4)
- The maximum number of 10Gb subports on a GigaVUE-TA400 is 128 (32 x 4)

The 100Gb QSFP28 ports (1/1/c1 to 1/1/c10 and 1/1/c23 to 1/1/c32) on the GigaVUE-TA200, GigaVUE-TA200E and GigaVUE-TA25 can be broken out into four 25Gb ports, called subports. In GigaVUE-TA25 only the ports c1 and c5 support **4 x25Gb** breakout mode. The subports will all have the same speed (25Gb). Subports will have x1 to x4 appended to their port ID, for example, when port 1/1/c2 on GigaVUE-TA200 is configured to 4x25G mode, the subports will be: 1/1/c2x1, 1/1/c2x2, 1/1/c2x3, and 1/1/c2x4.

- The maximum number of 25Gb subports on a GigaVUE-TA200 and GigaVUE-TA200E is 128 (32 x 4).
- In GigaVUE-TA25 the maximum number of 25Gb subports is 8 (2x 4)
- The maximum number of 25Gb subports on GigaVUE-TA25E is 32 (8x 4)
- The maximum number of 25Gb subports on a GigaVUE-TA400 is 128 (32 x 4).

In **4x25Gb** mode, the subports can function as network, tool, stack, circuit and hybrid ports. GigaStream port members can be activated in the tool, stack, and hybrid port types.

There are rules for configuring parent ports and subports. For more information, refer to the port command in the reference section of the GigaVUE-OS CLI Reference Guide. Once the port breakout mode has been configured, refer to [Breakout Panels](#).

For further information refer to [GigaVUE-OS Compatibility and Interoperability Matrix](#).

Breakout Panels

Breakout panels let you connect ports on a GigaVUE TA Series node to a tool or network port or TAP for port breakout or aggregation.

The following breakout panels are available:

- PNL-M341/PNL-M341T
- PNL-M343/PNL-M343T

Refer to [G-TAP M Series Hardware Guide](#) for details.

Getting Unpacked, Racked, Installed and Connected

The following steps are required to get a GigaVUE TA Series Traffic Aggregator mounted and running:

Unpacking the GigaVUE TA Series Traffic Aggregator

1. Unpack the GigaVUE TA Series Traffic Aggregator and inspect the box it was shipped in. If the carton was damaged, please file a claim with the carrier who delivered it.
2. Remove the protective shipping covers and screws. Save the protective shipping covers and replace the screws in the holes on the system so that they are easily saved in case you need to ship the system again.
3. Next, select a suitable location for the rack unit that will hold the GigaVUE TA Series Traffic Aggregation node. Choose a location that is clean, dust free, and well ventilated. You will need access to a grounded power outlet. Avoid areas where heat, electrical wire, and electromagnetic fields are generated.
4. Plan for enough clearance in front of a rack so you can open the front door completely (approximately 25in) and enough clearance in the back of the rack to allow sufficient airflow.

Rack-Mounting the GigaVUE TA Series

Safety Precautions

There are a wide variety of racks available on the market. Consult the instructions provided by the rack vendor for detailed mounting instructions before installing the GigaVUE TA Series Traffic Aggregation node.

NOTE: Before rack-mounting the GigaVUE TA Series, please read the following safety precautions:

- Install any stabilizers provided for the rack before installing the chassis. Unsecured racks can tip over.
- Install boxes in the rack from the bottom up with the heaviest boxes at the bottom.
- Ensure adequate ventilation to the systems installed in the rack.

This section describes how to rackmount the GigaVUE TA Series Traffic Aggregation node in a standard 1RU rack space using the hardware provided with the chassis. The node mounts in an EIA-standard 19in or 24in telco rack or equipment cabinet, up to 39in deep.

Rack Mounting GigaVUE-TA25E

The GigaVUE-TA25E consists a Rack mounting kit which has 2 front-post brackets, 2 rear-post brackets, 20 screws, and 2 ear-locking screws.

To rack mount the chassis do the following:

Attach the Brackets

1. Attach each of the front- and rear-post brackets to the node using four of the included bracket screws.
2. Use an additional two screws to secure each of the rear-post brackets at the mid-point on the sides of the node.
3. Use the screws and cage nuts supplied with the rack to secure the node in the rack.



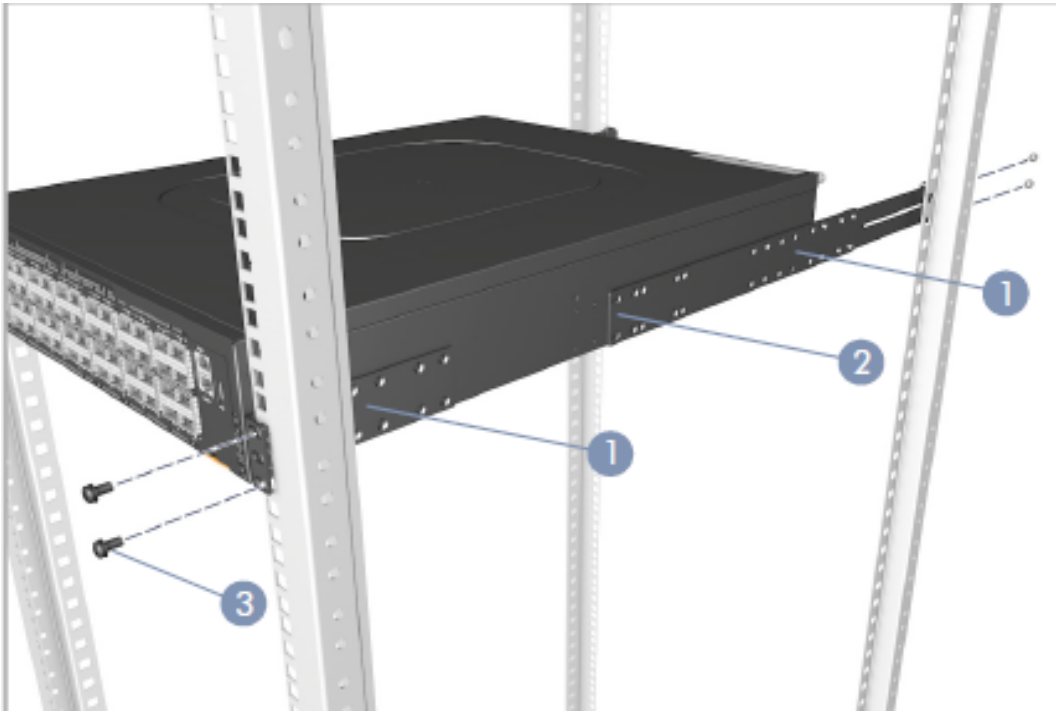

Caution: Installing the switch in a rack requires two people. One person should position the switch in the rack, while the other person secures it using the rack screws.

Adjust Rear-Post Bracket Ears

1. Lock the position of the rear-post bracket ears using the included position-locking screws. You can also adjust the rear-post bracket ears to fit different rack depths from 56 cm to 75 cm.

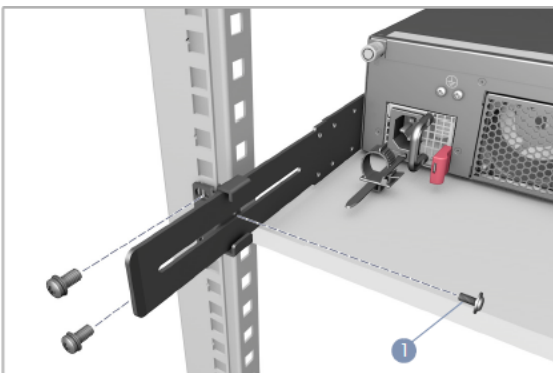

Basic Connections and Configuration

This chapter describes how to establish your first configuration session with the GigaVUE TA Series Traffic Aggregator and set the basic initial configuration options necessary to get you up and running.

Refer to the following sections for details:

Grounding the GigaVUE-TA25E

To ground the GigaVUE-TA25E do the following:

1. Ensure the rack is properly grounded and in compliance with ETSI ETS 300 253. Verify that there is a good electrical connection to the grounding point on the rack (no paint or isolating surface treatment).
2. Attach the grounding wire (#14 AWG) to the grounding point on the switch rear panel. Then connect the other end of the wire to rack ground.

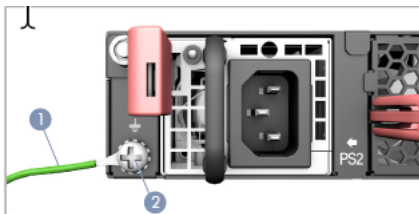

Caution: The earth connection must not be removed unless all supply connections have been disconnected.

Connecting Power to GigaVUE-TA25E

Follow below steps to connect power to the GigaVUE-TA25E:

1. Install one or two AC or DC PWR modules in the node. The node supports up to two PWR sources that must have the same matching airflow direction as the installed fan trays.

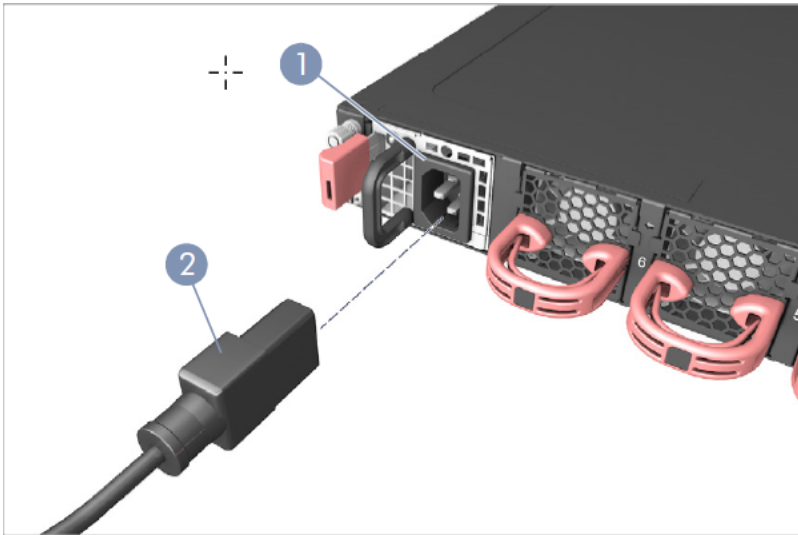

2. Connect an external AC or DC power source to the PWR modules.

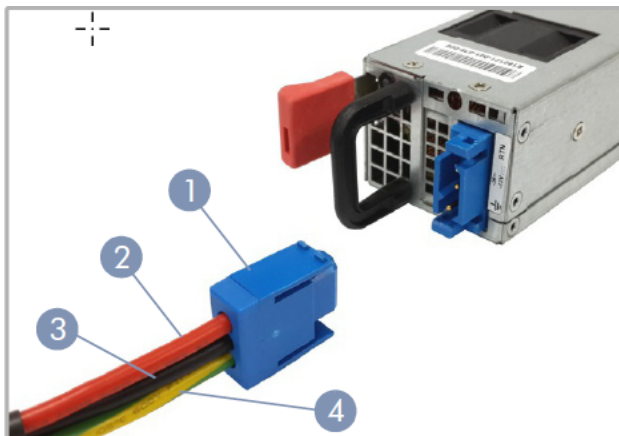

1. Positronic PLA03F7000/AA connector
2. DC Return
3. -36 – -72 VDC
4. Ground

Caution: Use a UL/IEC/EN 60950-1 certified power supply to connect to a DC converter, and a #14 AWG (for -36 VDC to -72 VDC PSU) wire to connect to a DC PSU.

Attention: Utilisez une alimentation certifiée UL/IEC/EN 60950-1 pour le connecter à un convertisseur CC et un câble AWG #14 (pour -36 VDC à -72 VDC) pour vous connecter à une alimentation CC.

Replacing Fans

Fans are field-replaceable. If a fan fails, you can replace it. Identify the fan that failed, and replace it with a working fan using the procedures in this section.

To remove a fan:

1. Locate lever and handle as shown below:

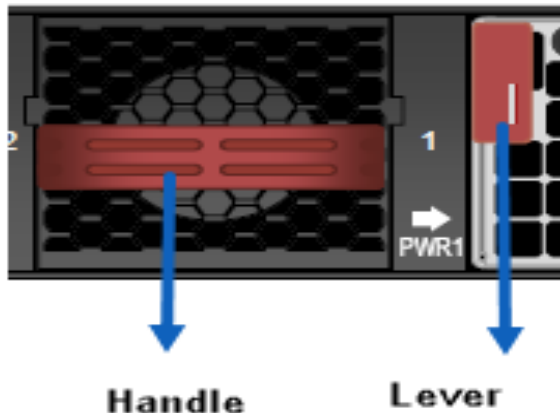

2. Push lever towards handle.
3. Pull on handle to remove the fan from the slot.

To insert a fan:

1. Place fan in empty slot.
2. Use handle to slide fan into slot.
3. When fan is fully inserted, it locks in place.

NOTE: The system will not power up without fan trays.

Connecting Serial Console and Mgmt Ports

To make basic connections (serial console and Mgmt ports):

1. Locate the DB9-to-RJ45 serial cable provided with the GigaVUE TA Series TA Series node. This cable is called a *console cable*.

NOTE: This cable is Cisco-compatible.

2. Connect the RJ45 end of the console cable to the **console** port.
3. Connect the DB9 end of the console cable to a PC's COM port.
4. Connect a standard Ethernet cable (Cat5 or better) to the 1000 **Mgmt** port.
5. Connect the other end of the ethernet cable to an Ethernet network.

NOTE: If you have connected GigaVUE-TA200E and GigaVUE-TA25E to serial or IPMI consoles, it is recommended that you enable BIOS passwords for the devices.

Port Licensing

GigaVUE-TA25E have all ports enabled. Additional ports are available through licenses for GigaVUE-TA25EA.

Contact your Sales representative for port licenses.

GigaVUE-TA25EA

The GigaVUE-TA25E has forty-eight (48) 25Gb/10Gb/1Gb and eight (8) 100Gb/40Gb ports enabled. It does not require a port license. A twenty-four (24) port GigaVUE-TA25E version, called the GigaVUE-TA25EA, is available with only the first twenty-four (24) 25Gb/10Gb/1Gb ports active. The GigaVUE-TA25EA product code is TA25EA, and the GigaVUE-TA25E product code is TA25E. A license is needed to expand the GigaVUE-TA25EA to include all forty-eight (48) 25Gb/10Gb/1Gb ports as well as the eight (8) 100Gb /40Gb ports. Use the following CLI command to display the GigaVUE-TA25EA chassis information:

```
(config) # show chassis

Chassis:
  Box ID       : 1*
  Hostname     : TA25EA
  Config       : yes
  Mode         : default
  Oper Status  : up
  HW Type      : TA25EA-Chassis
  Vendor       : Gigamon
  Product Code : TA25EA
  Serial Num   : 732656X2220342
  HW Rev       : 1.0
  SW Rev       : 6.8.00_Beta
  GDP          : disable
  Tag Mode     : double
```

Enabling Additional Ports

Contact your Sales Representative for information on obtaining a license key. Once you have obtained the license key for additional ports on GigaVUE-TA25EA, use the following command:

```
(config) # license install box-id <box ID> key <license key>
```

where

- box ID is the box ID of the GigaVUE TA Series node.

- license key is the license key obtained for the purposes of enabling additional ports. Use the following procedure to enable ports before starting to issue commands in the CLI:

1. Connect to the console port as described in the previous section.
2. Wait at least two minutes after the system prompt appears for the system to be initialized, and then switch to **Configure** mode.

The GigaVUE TA Series node provides three command entry modes, each with increasingly powerful rights – **Standard**, **Enable**, and **Configure**. The jump-start script is only available in Configure mode:

- a. Type **en <Enter>** to switch to Enable mode.

The system prompt changes from **[hostname]>** to **[hostname] #**.

- b. Type **config t <Enter>** to switch to Config mode.

The system prompt changes from **[hostname] #** to **[hostname] (config) #**.

3. Reset the terminal settings to match the current window with the following command:

terminal resize

4. Use the **port** command with the **admin** argument to enable ports. For example, the following two commands enable all available ports on a fully licensed GigaVUE-TA25EA:

(config) # port 1/1/c1..c8 params admin enable

(config) # port 1/1/x25..x48 params admin enable

Show port output without upgrade license for GigaVUE-TA25EA

```
TA25EA (config) # sh port
```

| Port | Type | Alias | Admin | Link Status | Kvrr (min) | Pwr (dBm) (max) | Pwr THld | Kvrr Type | Auto Neg | Speed (Mbps) | Duplex | Force LinkUp | Port Relay | Decryption | UDF |
|---------|---------|-------|----------|-------------|------------|-----------------|----------|-----------|----------|--------------|--------|--------------|------------|------------|-----|
| 1/1/c1 | network | - | inactive | - | -40.00 | -40.00 | - | qsfp28 sr | - | - | - | - | - | - | N/A |
| 1/1/c2 | network | - | inactive | - | -40.00 | -40.00 | - | qsfp28 sr | - | - | - | - | - | - | N/A |
| 1/1/c3 | network | - | inactive | - | -40.00 | -40.00 | - | qsfp28 sr | - | - | - | - | - | - | N/A |
| 1/1/c4 | network | - | inactive | - | -40.00 | -40.00 | - | qsfp28 sr | - | - | - | - | - | - | N/A |
| 1/1/c5 | network | - | inactive | - | -40.00 | -40.00 | - | qsfp+ sr | - | - | - | - | - | - | N/A |
| 1/1/c6 | network | - | inactive | - | -40.00 | -40.00 | - | qsfp+ sr | - | - | - | - | - | - | N/A |
| 1/1/c7 | network | - | inactive | - | -40.00 | -40.00 | - | qsfp+ sr | - | - | - | - | - | - | N/A |
| 1/1/c8 | network | - | inactive | - | - | - | - | none | - | - | - | - | - | - | N/A |
| 1/1/s1 | network | - | disabled | - | -40.00 | - | - | sfpsr sr | off | - | - | off | N/A | off | N/A |
| 1/1/s2 | network | - | disabled | - | -40.00 | - | - | sfpsr sr | off | - | - | off | N/A | off | N/A |
| 1/1/s3 | network | - | disabled | - | -25.99 | - | - | sfpsr sr | off | - | - | off | N/A | off | N/A |
| 1/1/s4 | network | - | disabled | - | -26.99 | - | - | sfpsr sr | off | - | - | off | N/A | off | N/A |
| 1/1/s5 | network | - | disabled | - | -40.00 | - | - | sfpsr sr | off | - | - | off | N/A | off | N/A |
| 1/1/s6 | network | - | disabled | - | -40.00 | - | - | sfpsr sr | off | - | - | off | N/A | off | N/A |
| 1/1/s7 | network | - | disabled | - | -40.00 | - | - | sfpsr sr | off | - | - | off | N/A | off | N/A |
| 1/1/s8 | network | - | disabled | - | -40.00 | - | - | sfpsr sr | off | - | - | off | N/A | off | N/A |
| 1/1/s9 | network | - | disabled | - | -40.00 | - | - | sfpsr sr | off | - | - | off | N/A | off | N/A |
| 1/1/s10 | network | - | disabled | - | -40.00 | - | - | sfpsr sr | off | - | - | off | N/A | off | N/A |
| 1/1/s11 | network | - | disabled | - | -26.58 | - | - | sfpsr sr | off | - | - | off | N/A | off | N/A |
| 1/1/s12 | network | - | disabled | - | -40.00 | - | - | sfpsr sr | off | - | - | off | N/A | off | N/A |
| 1/1/s13 | network | - | disabled | - | - | - | - | none | off | - | - | off | N/A | off | N/A |
| 1/1/s14 | network | - | disabled | - | - | - | - | none | off | - | - | off | N/A | off | N/A |
| 1/1/s15 | network | - | disabled | - | -40.00 | - | - | sfpsr lr | off | - | - | off | N/A | off | N/A |
| 1/1/s16 | network | - | disabled | - | -40.00 | - | - | sfpsr lr | off | - | - | off | N/A | off | N/A |
| 1/1/s17 | network | - | disabled | - | -40.00 | - | - | sfpsr lr | off | - | - | off | N/A | off | N/A |
| 1/1/s18 | network | - | disabled | - | -40.00 | - | - | sfpsr lr | off | - | - | off | N/A | off | N/A |
| 1/1/s19 | network | - | disabled | - | - | - | - | sfpsr ou | off | - | - | off | N/A | off | N/A |
| 1/1/s20 | network | - | disabled | - | - | - | - | sfpsr ou | off | - | - | off | N/A | off | N/A |
| 1/1/s21 | network | - | disabled | - | - | - | - | sfpsr ou | off | - | - | off | N/A | off | N/A |
| 1/1/s22 | network | - | disabled | - | - | - | - | sfpsr ou | off | - | - | off | N/A | off | N/A |
| 1/1/s23 | network | - | disabled | - | - | - | - | none | off | - | - | off | N/A | off | N/A |
| 1/1/s24 | network | - | disabled | - | - | - | - | none | off | - | - | off | N/A | off | N/A |
| 1/1/s25 | network | - | inactive | - | -40.00 | - | - | sfpsr sr | - | - | - | - | - | - | N/A |
| 1/1/s26 | network | - | inactive | - | -40.00 | - | - | sfpsr sr | - | - | - | - | - | - | N/A |
| 1/1/s27 | network | - | inactive | - | - | - | - | none | - | - | - | - | - | - | N/A |
| 1/1/s28 | network | - | inactive | - | - | - | - | none | - | - | - | - | - | - | N/A |
| 1/1/s29 | network | - | inactive | - | -40.00 | - | - | sfpsr lr | - | - | - | - | - | - | N/A |
| 1/1/s30 | network | - | inactive | - | -40.00 | - | - | sfpsr lr | - | - | - | - | - | - | N/A |
| 1/1/s31 | network | - | inactive | - | - | - | - | none | - | - | - | - | - | - | N/A |
| 1/1/s32 | network | - | inactive | - | - | - | - | none | - | - | - | - | - | - | N/A |
| 1/1/s33 | network | - | inactive | - | -40.00 | - | - | sfpsr lr | - | - | - | - | - | - | N/A |
| 1/1/s34 | network | - | inactive | - | - | - | - | none | - | - | - | - | - | - | N/A |
| 1/1/s35 | network | - | inactive | - | -40.00 | - | - | sfpsr lr | - | - | - | - | - | - | N/A |
| 1/1/s36 | network | - | inactive | - | - | - | - | none | - | - | - | - | - | - | N/A |
| 1/1/s37 | network | - | inactive | - | - | - | - | sfpsr ou | - | - | - | - | - | - | N/A |
| 1/1/s38 | network | - | inactive | - | - | - | - | sfpsr ou | - | - | - | - | - | - | N/A |
| 1/1/s39 | network | - | inactive | - | - | - | - | sfpsr ou | - | - | - | - | - | - | N/A |
| 1/1/s40 | network | - | inactive | - | - | - | - | sfpsr ou | - | - | - | - | - | - | N/A |
| 1/1/s41 | network | - | inactive | - | - | - | - | none | - | - | - | - | - | - | N/A |
| 1/1/s42 | network | - | inactive | - | - | - | - | none | - | - | - | - | - | - | N/A |
| 1/1/s43 | network | - | inactive | - | - | - | - | none | - | - | - | - | - | - | N/A |
| 1/1/s44 | network | - | inactive | - | - | - | - | none | - | - | - | - | - | - | N/A |
| 1/1/s45 | network | - | inactive | - | - | - | - | none | - | - | - | - | - | - | N/A |
| 1/1/s46 | network | - | inactive | - | -26.78 | - | - | sfpsr sr | - | - | - | - | - | - | N/A |
| 1/1/s47 | network | - | inactive | - | - | - | - | none | - | - | - | - | - | - | N/A |
| 1/1/s48 | network | - | inactive | - | -2.37 | - | - | sfpsr sr | - | - | - | - | - | - | N/A |

Legend : Power THld : ++ High Alarm + High Alert -- Low Alarm - Low Alert

Show port output with upgrade license for GigaVUE-TA25EA

```
TA25EA (config) # sh port
```

| Port | Type | Alias | Admin | Link Status | Xcvr | Per (min) | Per (max) | Pwr THld | Xcvr Type | Auto Neg | Speed (Mbps) | Duplex | Force LinkUp | Port Relay | Desoxy USE | |
|---------|---------|-------|----------|-------------|------|-----------|-----------|----------|-----------|----------|--------------|--------|--------------|------------|------------|-----|
| 1/1/s1 | network | - | disabled | - | - | -40.00 | -40.00 | - | qsfp28 sr | off | - | - | off | N/A | off | N/A |
| 1/1/s2 | network | - | disabled | - | - | -40.00 | -40.00 | - | qsfp28 sr | off | - | - | off | N/A | off | N/A |
| 1/1/s3 | network | - | disabled | - | - | -40.00 | -40.00 | - | qsfp28 sr | off | - | - | off | N/A | off | N/A |
| 1/1/s4 | network | - | disabled | - | - | -40.00 | -40.00 | - | qsfp28 sr | off | - | - | off | N/A | off | N/A |
| 1/1/s5 | network | - | disabled | - | - | -40.00 | -40.00 | - | qsfp28 sr | off | - | - | off | N/A | off | N/A |
| 1/1/s6 | network | - | disabled | - | - | -40.00 | -40.00 | - | qsfp28 sr | off | - | - | off | N/A | off | N/A |
| 1/1/s7 | network | - | disabled | - | - | -40.00 | -40.00 | - | qsfp28 sr | off | - | - | off | N/A | off | N/A |
| 1/1/s8 | network | - | disabled | - | - | - | - | - | none | off | - | - | off | N/A | off | N/A |
| 1/1/s9 | network | - | disabled | - | - | -40.00 | - | - | sfp sr | off | - | - | off | N/A | off | N/A |
| 1/1/s10 | network | - | disabled | - | - | -40.00 | - | - | sfp sr | off | - | - | off | N/A | off | N/A |
| 1/1/s11 | network | - | disabled | - | - | -40.00 | - | - | sfp sr | off | - | - | off | N/A | off | N/A |
| 1/1/s12 | network | - | disabled | - | - | -40.00 | - | - | sfp sr | off | - | - | off | N/A | off | N/A |
| 1/1/s13 | network | - | disabled | - | - | - | - | - | none | off | - | - | off | N/A | off | N/A |
| 1/1/s14 | network | - | disabled | - | - | - | - | - | none | off | - | - | off | N/A | off | N/A |
| 1/1/s15 | network | - | disabled | - | - | -40.00 | - | - | sfp lr | off | - | - | off | N/A | off | N/A |
| 1/1/s16 | network | - | disabled | - | - | -40.00 | - | - | sfp lr | off | - | - | off | N/A | off | N/A |
| 1/1/s17 | network | - | disabled | - | - | -40.00 | - | - | sfp lr | off | - | - | off | N/A | off | N/A |
| 1/1/s18 | network | - | disabled | - | - | -40.00 | - | - | sfp lr | off | - | - | off | N/A | off | N/A |
| 1/1/s19 | network | - | disabled | - | - | - | - | - | sfp ou | off | - | - | off | N/A | off | N/A |
| 1/1/s20 | network | - | disabled | - | - | - | - | - | sfp ou | off | - | - | off | N/A | off | N/A |
| 1/1/s21 | network | - | disabled | - | - | - | - | - | sfp ou | off | - | - | off | N/A | off | N/A |
| 1/1/s22 | network | - | disabled | - | - | - | - | - | sfp ou | off | - | - | off | N/A | off | N/A |
| 1/1/s23 | network | - | disabled | - | - | - | - | - | none | off | - | - | off | N/A | off | N/A |
| 1/1/s24 | network | - | disabled | - | - | - | - | - | none | off | - | - | off | N/A | off | N/A |
| 1/1/s25 | network | - | disabled | - | - | - | - | - | none | off | - | - | off | N/A | off | N/A |
| 1/1/s26 | network | - | disabled | - | - | -40.00 | - | - | sfp28 sr | off | - | - | off | N/A | off | N/A |
| 1/1/s27 | network | - | disabled | - | - | - | - | - | none | off | - | - | off | N/A | off | N/A |
| 1/1/s28 | network | - | disabled | - | - | - | - | - | none | off | - | - | off | N/A | off | N/A |
| 1/1/s29 | network | - | disabled | - | - | -40.00 | - | - | sfp lr | off | - | - | off | N/A | off | N/A |
| 1/1/s30 | network | - | disabled | - | - | -40.00 | - | - | sfp lr | off | - | - | off | N/A | off | N/A |
| 1/1/s31 | network | - | disabled | - | - | - | - | - | none | off | - | - | off | N/A | off | N/A |
| 1/1/s32 | network | - | disabled | - | - | - | - | - | none | off | - | - | off | N/A | off | N/A |
| 1/1/s33 | network | - | disabled | - | - | -40.00 | - | - | sfp28 lr | off | - | - | off | N/A | off | N/A |
| 1/1/s34 | network | - | disabled | - | - | - | - | - | none | off | - | - | off | N/A | off | N/A |
| 1/1/s35 | network | - | disabled | - | - | -40.00 | - | - | sfp28 lr | off | - | - | off | N/A | off | N/A |
| 1/1/s36 | network | - | disabled | - | - | - | - | - | none | off | - | - | off | N/A | off | N/A |
| 1/1/s37 | network | - | disabled | - | - | - | - | - | sfp ou | on | - | - | off | N/A | off | N/A |
| 1/1/s38 | network | - | disabled | - | - | - | - | - | sfp ou | on | - | - | off | N/A | off | N/A |
| 1/1/s39 | network | - | disabled | - | - | - | - | - | sfp ou | on | - | - | off | N/A | off | N/A |
| 1/1/s40 | network | - | disabled | - | - | - | - | - | sfp ou | on | - | - | off | N/A | off | N/A |
| 1/1/s41 | network | - | disabled | - | - | - | - | - | none | off | - | - | off | N/A | off | N/A |
| 1/1/s42 | network | - | disabled | - | - | - | - | - | none | off | - | - | off | N/A | off | N/A |
| 1/1/s43 | network | - | disabled | - | - | - | - | - | none | off | - | - | off | N/A | off | N/A |
| 1/1/s44 | network | - | disabled | - | - | - | - | - | none | off | - | - | off | N/A | off | N/A |
| 1/1/s45 | network | - | disabled | - | - | - | - | - | none | off | - | - | off | N/A | off | N/A |
| 1/1/s46 | network | - | disabled | - | - | -26.78 | - | - | sfp sr | off | - | - | off | N/A | off | N/A |
| 1/1/s47 | network | - | disabled | - | - | - | - | - | none | off | - | - | off | N/A | off | N/A |
| 1/1/s48 | network | - | disabled | - | - | -2.37 | - | - | sfp sr | off | - | - | off | N/A | off | N/A |

Legend : Power THld : ++ High Alarm + High Alert -- Low Alarm - Low Alert

5. Enter the **show license** command after enabling an additional 24 ports to check the applied port license.
6. Save your changes so that ports come up automatically at the next reboot:
write memory.

Advanced feature licensing GigaVUE-TA25E

GigaVUE-TA100, GigaVUE-TA200, GigaVUE-TA200E, GigaVUE-TA25E, GigaVUE-TA25 and GigaVUE-TA400 nodes can be clustered with GigaVUE TA Series HC Series nodes. Clustering is enabled with an Advanced Features License. Contact your Sales representative for Advanced Features Licenses. Refer to [Contacting Sales](#).

Command-Line Basics

This section provides a quick orientation to the GigaVUE TA Series command-line interface – how to enter commands, how to get help, and so on.

Command-Line Modes

The GigaVUE-OS can operate in one of three modes, each with its own set of available commands – Standard, Enable, and Configure. When you first launch the CLI, you start in Standard mode with access to a limited amount of commands used to review system status. As you move from **Standard** mode to **Enable** mode to **Configure** mode, both the power and the number of commands available increase, as summarized in [Figure 3 GigaVUE-OS Command-Line Modes](#).

NOTE: If you are working simultaneously with multiple GigaVUE TA Series nodes, you may want to assign each a separate hostname so its easy to identify separate terminal sessions from the system prompt. Admin users can do this in Configure mode with the **hostname <name>** command.

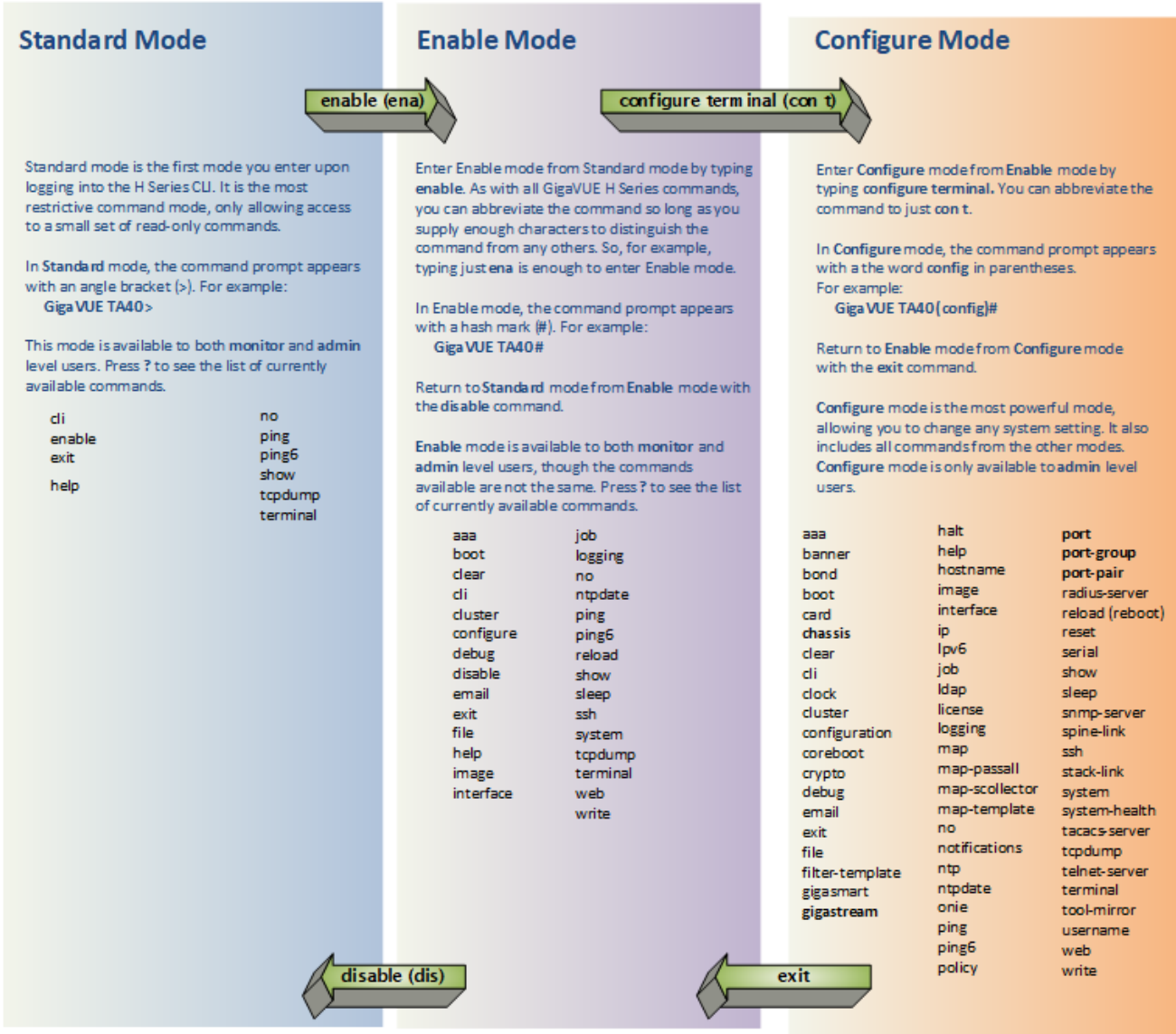

Figure 3 GigaVUE-OS Command-Line Modes

Entering Commands in the CLI

The GigaVUE TA Series CLI provides several conventions that make it easy to identify available commands and enter them quickly:

| Technique | Description |
|-------------------------------|--|
| Context-Sensitive Help | <p>The ? symbol is the key to receiving help wherever you are in the CLI:</p> <ul style="list-style-type: none"> ▪ Type the ? by itself to see a list of all available commands. ▪ Word Help – Type a partial word with a ? mark immediately following the partially-typed word to see a list of all possible commands using the word entered so far. <p>For example, if you typed i? in Configure mode, the CLI would return the following possible commands based on what you've entered so far:</p> <p>image interface ip</p> <ul style="list-style-type: none"> ▪ Command Help – Type a command followed by a question mark to see all possible arguments for the command as entered. If the system returns <cr>, that means the command can be entered as-is. <p>For example, if you entered gigastream ?, you would see alias. You can build your way through the entire command tree by entering ? after each new argument. For example, after entering gigastream alias myalias ?, you would see the next valid argument – port-list.</p> <p>NOTE: Typing ? accesses the help system immediately – you do not need to press <Enter>.</p> |
| Partial Command Entry | <p>For all GigaVUE TA Series commands and arguments, you only need to enter enough characters to distinguish the command from all other available commands. So, for example, you do not have to enter the full command username – there is only one command starting with the letter u, so you only have to enter u.</p> |
| Command Completion | <p>If you have partially typed a command, you can press Tab and the CLI will attempt to complete the command for you based on what's been entered so far.</p> <p>It is helpful to use the Command Completion feature together with partial command entry – you can press Tab while entering a command to see a list of all available commands matching what you've entered so far. For example, you can press p<Tab> and the system will return:</p> <p>pass-all ping port port-pair</p> |

| Technique | Description |
|-----------|--|
| | Based on this information, you know that you only need to enter the letter pa to uniquely identify what you've entered as pass-all . |

Command-Line Syntax – Entering Commands

You enter configuration commands for the GigaVUE TA Series node in the command-line interface by typing enough characters to uniquely identify the command and pressing **<Enter>**.

When entering commands, keep in mind the following rules:

- Successful commands return no response in the CLI; commands with errors return an error response beginning with **%**, followed by a short error description.
- All commands are case-sensitive and entered in lower case.
- Port numbers are entered in **<box ID>/<slot ID>/<port ID>** format. For the GigaVUE TA Series nodes, the chassis ID and slot number are always **1**.
- Strings must consist entirely of alphanumeric characters with no spaces. The only exceptions are the underscore (**_**), hyphen (**-**), exclamation point (**!**), “at” symbol (**@**), and period (**.**) characters. Those are allowed.

For example, in Config mode, **port 1/1/c12 alias My_Alias** is legal, but **port 1/1/c12 alias My Alias** is not.

NOTE: Some string fields do accept spaces provided the input is made inside quotation marks

Config Mode Syntax

When using the GigaVUE TA Series CLI, the “config” part of the command is implied whenever you are working in Configure mode. The system prompt helps you remember this by including the word **(config)** in parentheses. For example:

```
(config) #
```

So, instead of entering **config map** to connect a network port to a tool port, you just enter **map** followed by the necessary arguments. The **config** part is implied because you are already working in the Configure command mode. For example:

```
(config) # map alias myTA40map from 1/1/q1 to 1/1/q5
```

Paging through CLI Output

By default, the GigaVUE TA Series CLI returns output exceeding the configured terminal length in pages. The CLI provides the same features for working through the paged output as the Linux programs **less** and **more**. Press the **h** key to see paging options – [Figure 4 Viewing Paging Options](#) provides an example.

If you prefer, you can disable paging either for the current session or by default:

- **Disable for Current Session**

```
(config) # no cli session paging enable
```

- **Disable for All Sessions (Default)**
 (config) # no cli default paging enable

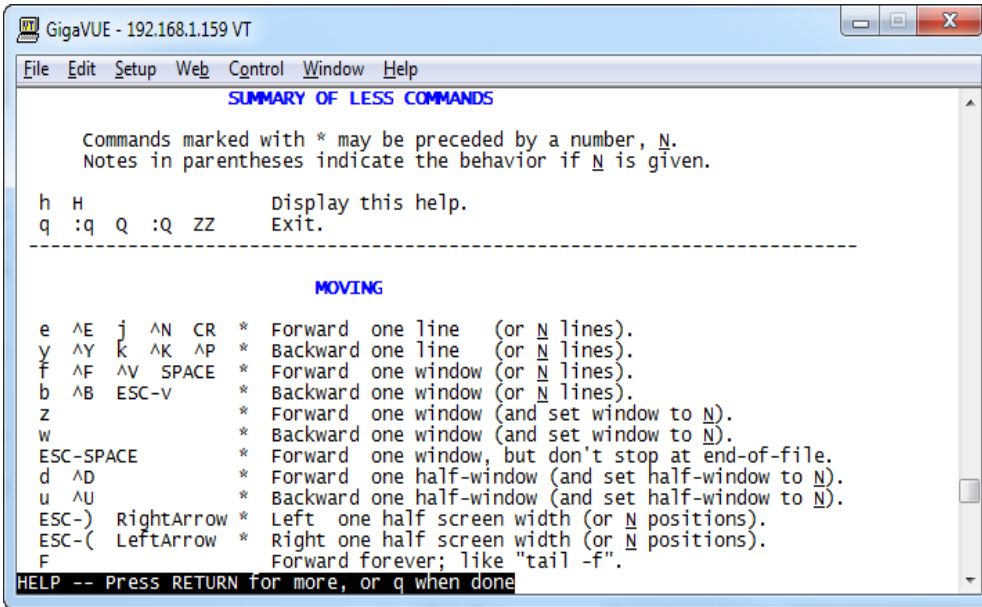

Figure 4 Viewing Paging Options

The Basic Commands

The following table lists each of the top level commands for the GigaVUE-OS CLI in Configure mode. Most commands have multiple supported arguments. You can see the exact arguments available at any point of command entry by typing it into the CLI followed by ?.

| Command | Description |
|----------------------|---|
| aaa | Configure authentication, authorization, and accounting settings. |
| banner | Set a system login banner. |
| bond | Configure bonded interface settings. |
| boot | Configure system boot parameters. |
| card | Configure a card. On GigaVUE TA Series nodes, use the card command to enable additional ports on GigaVUE TA Series nodes. |
| chassis | Configure the chassis. |
| clear | Reset statistics or clear caches. |
| cli | Configure CLI shell options. |
| clock | Set the system clock or timezone. |
| cluster | Configure a cluster of connected nodes. |
| configuration | Manage configuration files. |
| configure | Enter Configure mode. |

| Command | Description |
|-------------------------------|--|
| coreboot | Upgrades the BIOS image on GigaVUE-TA100, GigaVUE-HC1, GigaVUE-HC3 and GigaVUE-TA25. |
| crypto | Manage X.509 certificates for the node's Web server. |
| debug | Generate a dump file for use in debugging issues with Gigamon Technical Support. |
| disable | Leave Enable mode and return to Standard mode. |
| email | Configure email and event notification via email. |
| enable | Enter Enable mode. |
| exit | Leave Configure mode and return to Enable mode or log out of the CLI. |
| file | Manage TCP and debug dump files on disk. |
| filter-template | Configures flexible filter templates on GigaVUE-HC3, GigaVUE-TA100, and GigaVUE-TA25. |
| gigasmart | Configures a stack port interface to provide Internet connectivity for a GigaSMART card or module. |
| gigastream | Configure a GigaStream – a group of ports acting as a single addressable tool port destination or stack-link. |
| halt | Shut down the system without powering it off. |
| help | View a description of the interactive help system. |
| hostname | Specify the system's hostname. The hostname appears in the system prompt and in SNMP traps. |
| ib-pathway | Reserved for future use. |
| image | Manage system software images. |
| inline-network | Configures an inline network on GigaVUE TA Series nodes. |
| inline-network - group | Configures an inline network group on GigaVUE TA Series nodes. |
| inline-netlag | Configure Inline-Netlag. |
| inline-serial | Configures an inline tool series on GigaVUE TA Series nodes. |
| inline-tool | Configures an inline tool on GigaVUE TA Series nodes. |
| inline-tool-group | Configures an inline tool group on GigaVUE TA Series nodes. |
| interface | Configure network interfaces. |
| ip | Configure IP settings for the eth0 Mgmt port. |
| ipv6 | Configure IPv6 settings for the eth0 Mgmt port. |
| job | Configure scheduled jobs. |
| ldap | Configure LDAP server settings for authentication. |
| license | Activate features using license keys. GigaVUE-TA25 and GigaVUE-TA100, use this command to enable additional ports. (GigaVUE-TA25 has all ports enabled.) Use this command to enable clustering on the following GigaVUE TA Series nodes: GigaVUE-TA100 and GigaVUE-TA25. |
| logging | Configure event logging. |
| map | Configure maps and map rules to manage GigaVUE TA Series traffic distribution. |
| map-passall | Create a pass-all map to send all traffic on a network port to a tool port irrespective of the other packet distribution in place on the port. |

| Command | Description |
|-----------------------|--|
| <i>map-scollector</i> | Configure shared collector map parameters. |
| <i>map-template</i> | Create a map template. |
| <i>no</i> | Delete or clear certain configuration options. |
| <i>notifications</i> | Configures notification settings. |
| <i>ntp</i> | Enable and disable the use of NTP, as well as add NTP servers. |
| <i>ntpdate</i> | Set system clock once from a remote server using NTP. |
| <i>ping</i> | Send ICMP echo requests to a specified host. |
| <i>ping6</i> | Send ICMPv6 echo requests to a specified host. |
| <i>policy</i> | Configures an active visibility policy. |
| <i>port</i> | Configure port type, parameters, and filters. |
| <i>port-group</i> | Create a group of ports. |
| <i>port-pair</i> | Configure a port-pair on a pair of network ports within the same node. A port-pair is a bidirectional connection in which traffic arriving on one port in the pair is transmitted out the other (and vice-versa) as a passthrough TAP. |
| <i>radius-server</i> | Configure RADIUS server settings for authentication. |
| <i>reload(reboot)</i> | Reboot or shut down the node. |
| <i>reset</i> | Reset specified portions of the system configuration to their factory states. |
| <i>serial</i> | Set options for the serial console port. |
| <i>sfp</i> | Reserved for future use. |
| <i>show</i> | Display configuration and status information for a wide variety of settings and entities. |
| <i>sleep</i> | Sleep for a specified number of seconds. |
| <i>snmp-server</i> | Configure SNMP settings, including the local SNMP server, notification events, and notification destinations. |
| <i>spine-link</i> | Configures spine links in a cluster with a leaf and spine architecture. |
| <i>ssh</i> | Enable and disable SSH access, as well as manage settings. |
| <i>stack-link</i> | Configure a stack-link between two nodes in a cluster. Stack-links are used to carry data traffic between nodes in a cluster. |
| <i>system</i> | Change system settings. |
| <i>system-health</i> | Configures system health behaviors. |
| <i>tacacs-server</i> | Configure TACACS+ server settings for authentication. |
| <i>tcpdump</i> | Display packets from any ethx port in the node on a network. |
| <i>terminal</i> | Set terminal parameters, including width and length. |
| <i>tool-mirror</i> | Configures a tool-mirror connection between two tool ports. A tool-mirror connection sends all packets arriving on one tool port to a second tool port on the same node. |
| <i>traceroute</i> | Trace the route packets take to a destination. |
| <i>tunnel</i> | Reserved for future use. |
| <i>uboot</i> | Installs new uboot software. |

| Command | Description |
|-----------------------|---|
| <code>username</code> | Manage user accounts. |
| <code>web</code> | Configure the Web server used for GigaVUE-FM GUI support on the node. |
| <code>write</code> | Save the running configuration to persistent storage. |

Completing the Initial Setup

At this point, you have logged in to the command-line interface using the **admin** account, configured the **Mgmt** port's network properties for SSH access, and have explored the command-line interface.

There are a few more steps you should perform to complete the initial configuration before you set up network ports, tool ports, and aggregate traffic. These tasks include:

- Switch to the Configure mode. Refer to [Enter the Configure Command-Line Mode](#).
- Configure SSH access to the node. Refer to [SSH2](#).
- Configure some basic user accounts. Refer to [Initial User Account Configuration](#).
- Configure the node name. Refer to [Configuring the GigaVUE TA Series Host Name](#).
- Configure time and date options for the node. Refer to [Configuring GigaVUE TA Series Node's Time Options](#).
- Configuring Internet Explorer for Use with GigaVUE-FM. Refer to [Configuring Internet Explorer for Use with GigaVUE-FM](#).
- Save your changes! Refer to [Saving Changes](#).

Enter the Configure Command-Line Mode

Keep in mind that the GigaVUE-OS have three different command modes for the CLI – **Standard**, **Enable**, and **Configure**. The commands described in the sections below are all only available in Configure mode. Switch to configure mode as follows:

| Command | Notes |
|-----------------------------------|---|
| <code>> enable</code> | You only need to supply enough of each command to positively identify it among the other available commands. So, in this example, you could just type ena and press Enter. |
| <code># configure terminal</code> | Similarly, this command can be entered as con t . |
| <code>(config) #</code> | Notice how the system prompt changes with each command mode. Command modes offer greater control over the box as you ascend from Standard to Enable to Configure . |

SSH2

SSH2 is available for remote connections to the GigaVUE TA Series Traffic Aggregator's **Mgmt** port. By default, SSH2 is enabled. Use the **ssh** commands in Configure mode to enable or disable the corresponding connections. To disable the corresponding

connection, you include **no** before the command, as demonstrated in the table below. For example:

| Command | Notes |
|--|--|
| Enable: (config) # ssh server enable Disable: (config) # no ssh server enable | When SSH2 is enabled, you can use any compliant SSH2 client to connect to the command-line interface remotely. For example, to connect using the SSH2 client, PuTTY: <ol style="list-style-type: none"> Start PuTTY and enter the GigaVUE TA Series Traffic Aggregator's IP address in the Host Name field. Click the SSH protocol radio button. Click Open to open a connection. If this is your first connection PuTTY warns you that the host key presented by the GigaVUE TA Series node is not in your cache. You can add the key, connect without adding the key, or cancel the connection. Refer to Verifying Host Keys During Connection for information on how to verify that the host key shown is the correct one. Log in with GigaVUE TA Series credentials. |

Advantages of SSH2

SSH2 is a secure choice for remote connections, providing an encrypted channel instead of relying on clear text. It also provides stronger user authentication capabilities, including the use of a public **host key**. Host keys uniquely identify a server, helping guarantee that the server you're connecting to is the server you think it is. The GigaVUE TA Series nodes also include default RSA v1/v2 and DSAv2-encrypted public host keys (SSH2 supports both RSA and DSA encryption algorithms). The first time you connect to the GigaVUE TA Series node with an SSH2 client, the client will warn you that the host keys are not in your local cache and show you the actual host key presented by the node. Your client will most likely give you the option of trusting the key, adding it to your local cache. Once you've trusted the key, your client will alert you during connection if a different key is presented.

IMPORTANT: Telnet server functionality is no longer supported as of GigaVUE-OS 5.7.00.

Verifying Host Keys During Connection

To verify that the host key presented during an SSH2 connection is in fact the GigaVUE TA Series node's, you can connect over the console port (refer to [Access the Command-Line Interface over the console Port](#)) and use the **show ssh server host-keys** command to see the current public host keys and fingerprints for the GigaVUE TA Series node. Paste these in a file and keep them nearby when you connect via SSH2 the first time. This way, you'll be able to compare the actual host key to what your SSH2 client says is being presented. Once you've verified that they are the same, you can choose to trust the host key, allowing future connections to take place seamlessly.

Changing Host Keys

You can use the **ssh server host-key generate** command to change the default host keys provided with the GigaVUE TA Series node. The command has the following syntax:

```
ssh server host-key <rsa1 | rsa2 | dsa2> <private-key | public-key> generate
```

For example, to configure a new RSAv1 public hostkey, you could use the following command:

```
(config) # ssh server host-key rsa1 public-key generate
```

Initial User Account Configuration

Before you start mapping traffic, you must change the password for the **admin** account and add a few other accounts for use by different level users. (You may have already used the jump-start script to change the password for the **admin** account.)

Changing the admin Account Password

1. To change the password for the **admin** account using the **username** command, refer to the following:

```
(config) # username admin password <password>
```

Passwords must meet the following standards:

- Include 8-30 characters.
- Include at least one numeral
- Include at least one capital letter
- Include at least one special character (for example, **!**, **@**, **#**, **\$**, **%**, **^**, **&**, or ***** – ASCII [0x21, 0x2F], [0x3A, 0x40], [0x5B, 0x5F], [0x7B,0x7E]).

Enter a new password that meets the standards and confirm the password.

Setting Up Some Basic Accounts

1. The GigaVUE TA Series node has a local account database that can optionally integrate with an LDAP, RADIUS, or TACACS+ server for authentication. Any account you want to authenticate using an external AAA server must have a matching account name in the local database.

Authentication, user levels, and roles are discussed in detail in the *GigaVUE-OS CLI Reference Guide*. For now, however, it is easiest to simply create a few basic user accounts with different privilege levels. In general, user privileges are as follows:

- Admin users have access to all command modes, including Standard, Enable, and Configure. They also have full permissions for all network, tool, and stack ports.
- Operator users have access to all command modes, including Standard, Enable, and Configure. However, they only have access to the network and tool ports associated with their user group. New users are created with the operator role by default. You can add additional roles with the **username <username> roles add <roles>** command.

- Monitor users have access to the Standard and Enable command modes. They cannot configure packet distribution (or any other global GigaVUE TA Series node options), but they can use the show command to review many of the settings in place on the node.

The following username commands create a new admin user and a new operator user:

| Command | Comments |
|---|--|
| <pre>(config) # username psandoval password Nine9.Eight8! (config) # username psandoval roles add admin</pre> | Creates a new account named psandoval with a password and grants it admin privileges. |
| <pre>(config) # username bcrawford password Seven7.Six6!</pre> | Creates a new account named bcrawford with a password. New users are automatically created with default operator level privileges, so there is no need to grant an additional role. |

2. Once you have configured these basic user accounts, use the **show usernames** command to review your settings. [Figure 5 Reviewing the User List](#) shows some sample **show usernames** output after several users have been added.

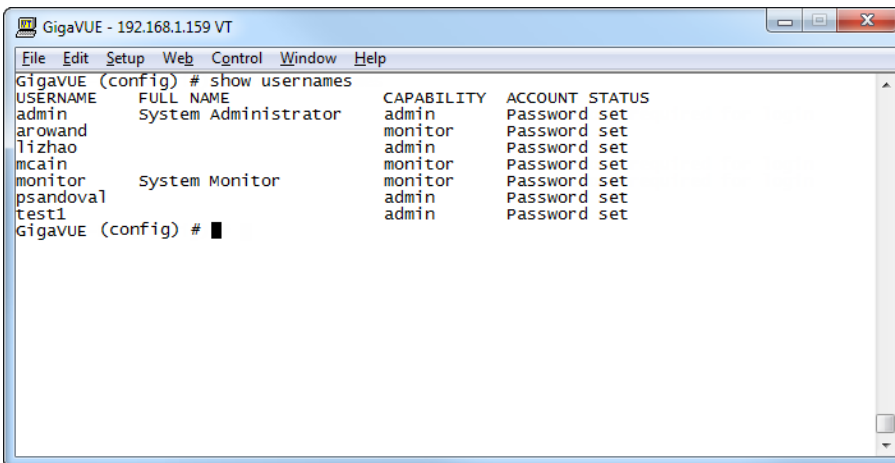

Figure 5 Reviewing the User List

Configuring the GigaVUE TA Series Host Name

It is generally a good idea to configure the GigaVUE TA Series node’s name, date, and time as part of your initial configuration. The following command shows how to set the system name. Refer to [Configuring GigaVUE TA Series Node’s Time Options](#) for information on setting options related to time and date.

Setting the System Name

1. Use the **hostname** command to specify the system name. For example:
(config) # hostname GigaVUE TA Series-Customer

Configuring GigaVUE TA Series Node's Time Options

The GigaVUE TA Series nodes include a variety of features for setting the time, including:

| Method | CLI Command | For more information: |
|---------------------------------------|--|--|
| System Clock | clock set hh:mm:ss yyyy/mm/dd | Setting Time Manually |
| One-Time NTP Synchronization | ntpdate <ntpserver address> | Performing One-Time NTP Server Synchronization |
| Persistent NTP Synchronization | Add server using ntp server command. Enable use of ntp with ntp enable command. | Using NTP Time Server for System Clock Synchronization |

Setting Time Manually

The easiest way to set the GigaVUE TA Series node's time is manually with the **clock set** command. For example:

```
(config) # clock set 05:18:38 2011/05/24
```

NOTE: Even if you are using NTP/SNTP, It is a good idea to configure time manually as well. The GigaVUE TA Series node will automatically fall back to the manual time setting if it is unable to synchronize with the specified time server.

The **show ntp** will show the current state of the NTP server in use; the **show clock** command shows the current GigaVUE TA Series node's time.

Performing One-Time NTP Server Synchronization

You can perform a one-time synchronization with an NTP server using the **ntpdate** command. For example:

```
(config) # ntpdate time.nist.gov
```

Note that this method does not provide updates to correct clock drift over time. It is generally preferable to use persistent NTP synchronization with the **ntp** commands.

Using NTP Time Server for System Clock Synchronization

The GigaVUE TA Series nodes can optionally use one or more NTP servers for its time setting. Use the following procedure to add an NTP server to the GigaVUE TA Series node's list and enable the use of NTP.

1. Specify the address of the time server. For example, if the time server is on 192.168.1.10, you would use the following command:

```
(config) # ntp server 192.168.1.10
```

NOTE: There are many public NTP servers available on the Internet.

2. Turn on NTP with the following command:

```
(config) # ntp enable
```

3. The GigaVUE TA Series node connects to the specified NTP server and synchronizes to its time.
4. NTP reports times in UTC. Because of this, It is a good idea to specify the GigaVUE TA Series node's timezone so that UTC can be converted to the local timezone.

You specify the timezone in terms of the offset from UTC (either plus or minus). For example, to set the timezone for a GigaVUE TA Series node in the United States for Pacific Standard Timezone, you would use the following command:

(config) # clock timezone America North United_States Pacific

Once you've finished configuring NTP options, use the **show ntp** command to check the status of clock synchronization ([Figure 6 Checking NTP Status and Configuration](#)).

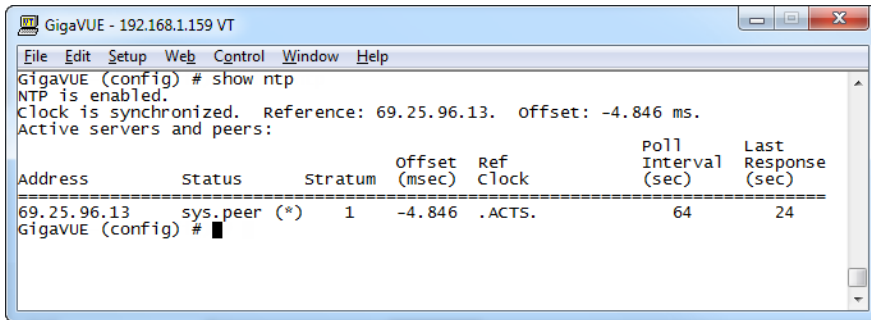

Figure 6 Checking NTP Status and Configuration

Configuring Internet Explorer for Use with GigaVUE-FM

GigaVUE-FM works best in Internet Explorer when the browser is configured to check for newer versions of stored pages every time pages are visited. Enable this option as follows:

1. Open Internet Explorer.
2. Select the **Tools > Internet Options** command.
3. In the **General** tab, locate the **Browsing history** section and click its **Settings** button.
4. Set the **Check for newer version of stored pages:** option to **Every time I visit the webpage.**
5. Click **OK** on the Temporary Internet Files and History Settings dialog.
6. Click **OK** on the Internet Options dialog.

Configuring Automatic Email Notifications

The GigaVUE TA Series nodes provide powerful email notification capabilities, automatically sending emails to specified addresses when any of a wide variety of events take place on the system. Gigamon strongly recommends that you configure this feature so you have immediate visibility of events affecting system health.

You configure automatic email notifications with the **email** command and its arguments. Start by making sure the CLI is in Configure mode. If the **(config)** entry appears in the system prompt, you are in Configure mode. If not, use the **enable** and **configure terminal** commands sequentially to change to Configure mode. Then, configure email notifications as follows:

| Description | Command |
|---|---|
| First, use the email mailhub command to specify the mail server to use for notification emails. In this example, the email server named smtp.emailsrvr.com is used. IP address can be used instead of a hostname. | (config) # email mailhub smtp.emailsrvr.com |
| Next, use the email auth command to supply the email account username and password. In this example, alerts@mycompany.com is shown with a password of mypassword123 . | (config) # email auth username alerts@mycompany.com (config) # email auth password mypassword123 |
| Once account is setup turn on email authentication. | (config) # email auth enable |
| Now that the settings are configured, let the system send emails. Set up who to send them to and when to send them. Use email notify recipient to configure the destinations for event notification emails. Multiple destinations can be specified by separating by commas with no spaces. | (config) # email notify recipient cday@mycompany.com,mfelton@mycompany.com |
| The email notify event command lets you configure which events will trigger automatic emails. There are quite a few events available – start by entering email notify event ? to see the list of available events. You can either enable individual | (config) # email notify event all |

| Description | Command |
|--|--|
| events, or, use the all argument to enable them all. | |
| It is a good idea to check your settings and make sure emails are sent successfully. You can do that with the email send-test command. If you do not receive the email, check the show log output to make sure the email was sent. Then, reconfigure email settings, if necessary. | (config) # email send-test |
| You may also want to configure and enable autosupport emails. Autosupport emails are sent directly to Gigamon's Technical Support department when specified events take place, enabling proactive problem resolution. The GigaVUE TA Series is preconfigured with the correct destination address – you just need to enable the feature with the following command. Use show email events to see the list of events for which autosupport emails will be sent. You can change the list with the (no) email autosupport event command. | (config) email autosupport enable |
| <p>That's it! Emails will now be sent automatically to the configured addresses when any of the selected events take place.</p> <p>There are many other options for fine-tuning automatic email settings, including how to handle "dead letters" (emails that did not reach their recipient), how the email address of the GigaVUE TA Series should appear, the port for the email server, the reply-to address, and so on.</p> | |

Using a Custom Banner

The GigaVUE TA Series nodes can display a customizable text banner at system startup before a user logs in. This way, users connecting to the system see the banner before they log in, giving them an idea of which system they are logging in to. The banner also

appears after a user logs out.

Use the **banner login** “<string>” command to configure the login banner. For example:

```
(config) # banner login "Pacific Call Center"
```

NOTE: You only need to use quotation marks for the <string> if it includes spaces.

The next time you log in or out of the GigaVUE TA Series node, you will see the customizable banner.

Saving Changes

It is a good idea to get into the habit of using the **write memory** command to save changes as you make them. Later on, when you start setting up packet distribution, your changes will be added to the active configuration right away but would not be saved across a system reboot unless you use the **write memory** command to save your changes to flash.

NOTE: The name of the factory-provided configuration file is **initial**. You can refer to the name of the most recently booted configuration file by using the **show running-configuration** command (or **show configuration**) and look for the **## Running database** entry.

Connecting Ports on GigaVUE[®] TA Series

This chapter provides information on the transceivers supported for use with the GigaVUE TA Series.

Refer to the following sections for details:

Transceiver—Rules and Notes

Keep in mind the following rules and notes when you connect and use GigaVUE TA Series nodes with transceivers:

- Always use transceivers purchased from Gigamon to ensure interoperability and performance. Gigamon does not support transceivers purchased from other vendors.
- After removing an optical transceiver, the best practice is to wait seventeen (17) or more seconds before re-inserting the same or different optical transceiver. This includes the intervals between removal/insertion/re-insertion.
- Use the **show port params all** command to see transceiver type information for each of the network/tool ports in the GigaVUE TA Series nodes. Check the value of the **SFP type** field for the ports in question.

- Following are the nomenclatures for the GigaVUE TA Series node port numbers:
 - Port numbers starting with a c (for example, c1) are 100Gb. They can also support 40Gb depending on the transceiver installed.
 - Port numbers starting with a q (for example, q1) are 40Gb.
 - Port numbers starting with an x (for example, x10) are 10Gb or 1Gb or 25Gb depending on the transceiver installed. They can also support 25 Gb on select platforms.

NOTE: The 40Gb QSFP+ SR Full Duplex (RX/TX) transceiver is not supported in conjunction with a TAP.

- For details about the supported transceivers, cable types, and connectivity specifications, refer to [“GigaVUE-OS Compatibility and Interoperability Matrix”](#).

BiDi Optics Considerations

There are several nuances to consider due to the complexity in 40Gb BiDi technology. Because of the nature of 40Gb BiDi technology, the same BiDi optic (Full Duplex or RX-only) cannot be used in all of the following situations. For example:

- On SPAN sessions, RX-only BiDi optics cannot be used. Full Duplex BiDi optics must be used.
- When receiving traffic from network links, RX-only BiDi optics must be used due to the way traffic is multiplexed over the fiber pair in 40Gb BiDi technology.
- When deploying over inline 40Gb BiDi links, Full Duplex BiDi optics must be used.
- When connecting two GigaVUE TA Series nodes through a cascade connection, Full Duplex BiDi optics must be used for the tool port. The network port may be either Full Duplex or RX-only BiDi optics.
- When stacking multiple GigaVUE TA Series nodes, 40Gb BiDi optics must not be used on stack links because the 40Gb BiDi technology is not compatible with the Gigamon stack protocol.

Transceiver Installation Instructions

Gigamon transceivers are keyed and can only be installed in one direction. Transceivers are hot-swappable – they can be installed or removed with the power on or off. Use the following procedures to install and remove SFPs from GigaVUE TA Series node.

IMPORTANT: Always use an ESD-preventive wrist or ankle strap and ensure that it makes good skin contact when installing or removing transceivers.

MPO Cabling

Refer to the following sections for MPO cabling:

- [MPO/MTP 12 Position Fiber Cable for Use with SR4 Transceivers](#)
- [MTP/APC Fiber Cable for Use with QSFP+ PLR4 Transceivers](#)

- MPO/MTP 24 Position Fiber Cable for Use with SR10 Transceivers
- For details about the supported transceiver, cable type, and connectivity specifications, refer to “[GigaVUE-OS Compatibility and Interoperability Matrix](#)”.
- For details about how to cable GigaVUE TA Series nodes, refer to “[GigaVUE-OS Pluggables Guide](#)”.

MPO/MTP 12 Position Fiber Cable for Use with SR4 Transceivers

This is a female to female Multi-fiber Push On (MPO) / Ultra Polished Connector (UPC) of cable type B. [Figure 7 MPO/MTP 12 Position Fiber Cable](#) provides cabling details for MPO/MTP 12 position fiber cable for use with 40Gb SR4 QSFP+, 40Gb ESR4 QSFP+, and 100Gb ER4 QSFP28 and 100Gb SR4 QSFP28 transceivers.

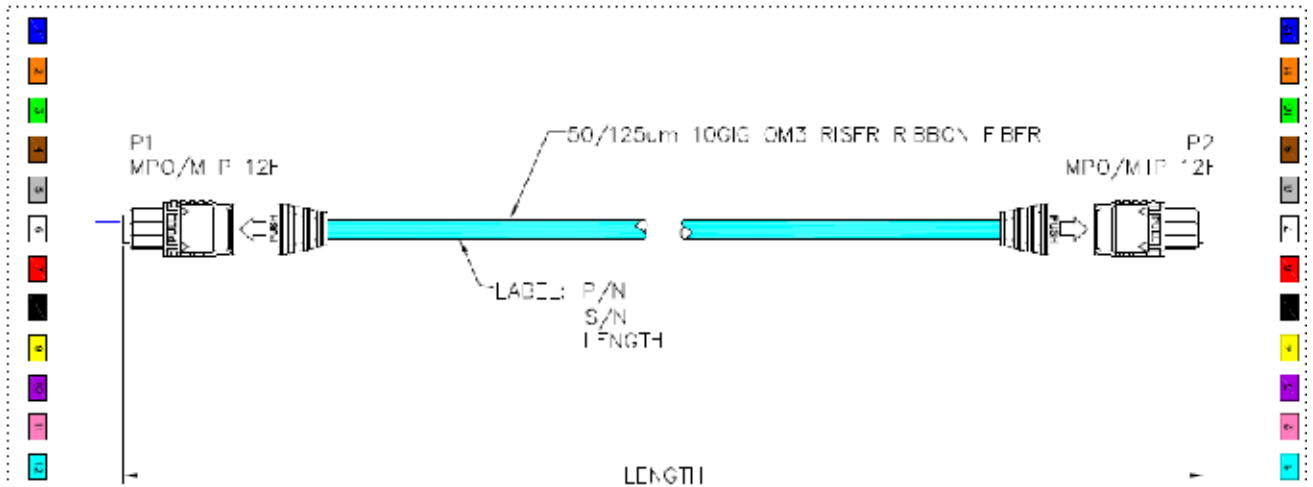

Figure 7 MPO/MTP 12 Position Fiber Cable

MTP/APC 12 Position Fiber Cable for Use with QSFP+ PLR4 Transceivers

The MTP cable is a high performance MPO connector. This is a female to female Angled Polished Connector (APC) of cable type B with an 8-degree angled end-face and a diameter of 9/125µm. [Figure 8 MTP/APC Cable](#) provides details for MTP/APC 12 position fiber cable for use with 40Gb QSFP+ PLR4 transceivers on the GigaVUE-TA100 node.

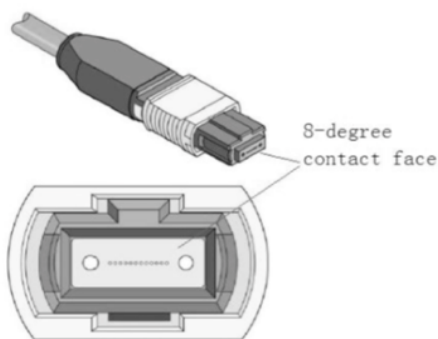

Figure 8 MTP/APC Cable

MPO/MTP 24 Position Fiber Cable for Use with SR10 Transceivers

This is a female to female Ultra Polished Connector (UPC) of cable type B. [Figure 9 MPO/MTP 24 Position Fiber Cable](#) provides cabling details for MPO/MTP 24 position fiber cable for use with 100Gb SR10 CXP transceivers.

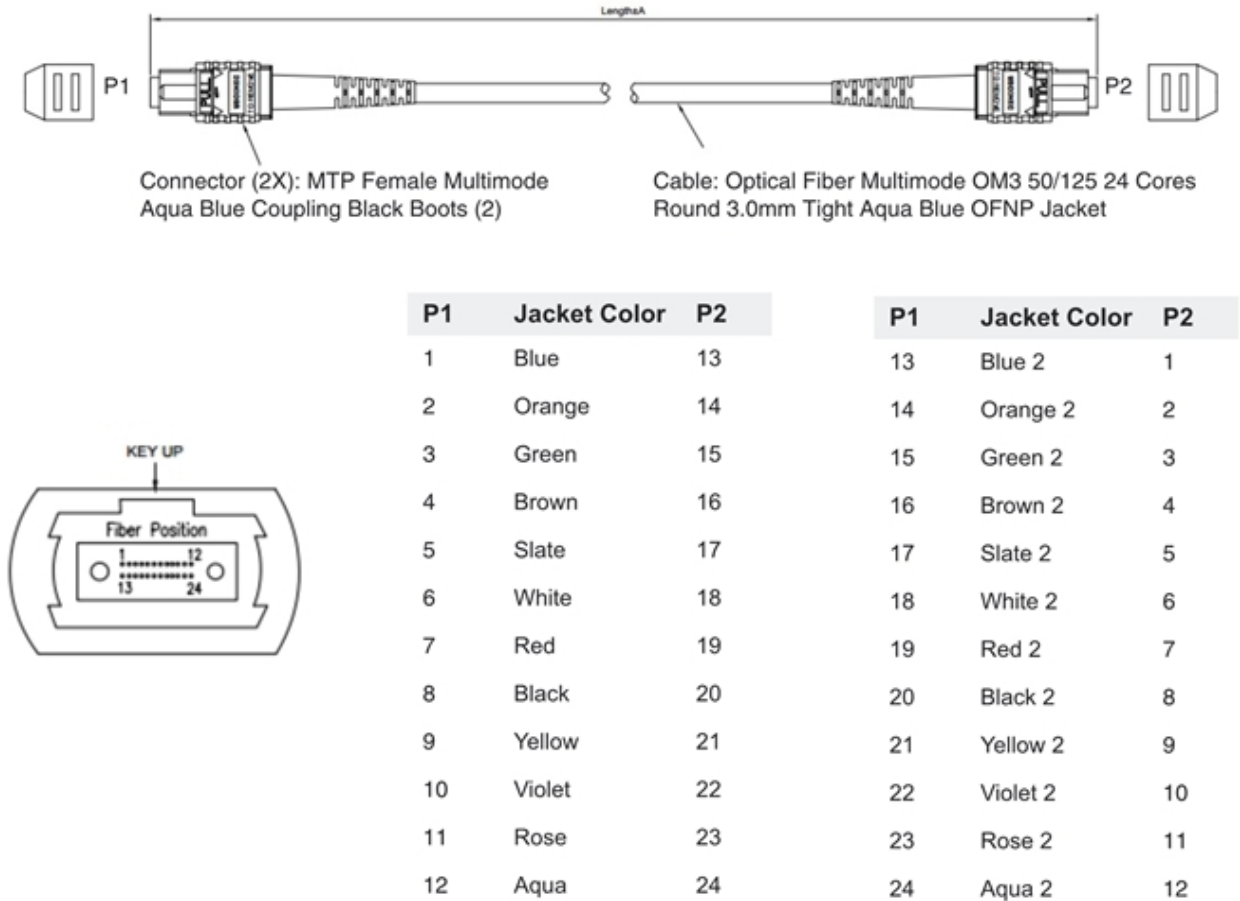

Figure 9 MPO/MTP 24 Position Fiber Cable

GigaVUE[®] TA Series Specifications

This section provides the physical specifications, power requirements and environmental specifications for the GigaVUE TA Series Traffic Aggregation node. Compliance for safety, emissions and immunity are also provided.

Physical Dimensions and Weight

The following table summarizes the dimensions for the GigaVUE Traffic Aggregation node GigaVUE-TA25E :

| Product | Height | Width | Depth | Weight (AC Version) |
|---------------|---------------------------|---------------------|----------------------------------|---------------------|
| GigaVUE-TA25E | 1.71 in (1RU) (43.5mm) | 17.26 in (438.4 mm) | Metal to Metal 21.1in(536 mm) | 22.05lb (10kg) |

Power Requirements

Each GigaVUE TA Series node come standard with dual, load sharing power supplies. [Table 2: Power Requirements for GigaVUE-TA25E](#) summarize the electrical characteristics for the GigaVUE TA Series Traffic Aggregation node, GigaVUE-TA25E.

NOTE: Refer to [Connecting Power to GigaVUE-TA25E](#) for instructions on how to connect power supplies.

Table 2: Power Requirements for GigaVUE-TA25E

| | |
|---|--|
| Power Configurations | 1+1 Power: 2 Power Supply Modules |
| Max Power Consumption/ Heat Output | 550 Watts |
| AC Power Supply Modules | Min/Max Voltage: 100V–240 VAC, 50/60Hz Max PSM Input Current: 6A@100V-240VAC |
| DC Power Supply Modules | Min/Max Voltage: -36 to-72 VDC Max PSM Input Current (Steady State): 16A@ 48VDC |

Fan Tray Specification for GigaVUE-TA25E

The GigaVUE-TA25E uses a fan tray for cooling. The below table summarizes the characteristics of the fan tray.

Table 3: GigaVUE-TA25E Fan Tray Specifications

| | |
|----------------------|----------------------|
| Rated Voltage | 12V DC |
| Input Power | Maximum 18W |
| Maximum Speed | 9000 RPM |
| Type | Dual axial flow fans |

Environmental Specifications

Table 4: Environmental Specifications for GigaVUE TA Series-TA25E summarizes the environmental specifications for the GigaVUE TA Series Traffic Aggregation node.

Table 4: Environmental Specifications for GigaVUE TA Series-TA25E

| Specification | Value |
|---------------------------------------|--|
| Operating Temperature | 32°F to 113°F (0°C to 45°C) Front to Back 32°F to 104°F (0°C to 40°C) Back to Front |
| Operating Relative Humidity | 5% to 95%, non-condensing |
| Recommended Storage Temperature | -40°F to 158°F (-40°C to 70°C) |
| Recommended Storage Relative Humidity | 15% to 85%, non-condensing |
| Altitude | Up to 13000ft (3.96km) for , GigaVUE-TA25E |

Compliance GigaVUE-TA25E

This section provides compliance information for GigaVUE® TA Series Traffic Aggregation nodes.

Safety

UL (CSA 22.2 No 60950-1 & UL60950-1)

CB (IEC/EN60950-1)

CCC GB4943.1-2011

BSMI, CNS 14336-1

Immunity

EN 55024:2010+A1:2015

IEC 61000-4-2/3/4/5/6/8/11

Emissions

EN 55032:2015+AC:2016, Class A

EN 61000-3-2:2014, Class A

EN 61000-3-3:2013

FCC Class A

VCCI Class A

CCC GB 9254-2008, Class A

BSMI Class A, CNS 13438

Warranty

Gigamon offers a range of premium support and extended services. For details regarding warranty, visit: <https://www.gigamon.com/support/warranty>.

Regulatory Label GigaVUE-TA25E

This section provides regulatory labels for GigaVUE-TA25E node.



Additional Sources of Information

This appendix provides additional sources of information. Refer to the following sections for details:

- [Documentation](#)
- [Documentation Feedback](#)
- [Contact Technical Support](#)
- [Contact Sales](#)
- [The VUE Community](#)

Documentation

This table lists all the guides provided for GigaVUE TA Series software and hardware. The first row provides an All-Documents Zip file that contains all the guides in the set for the release.

NOTE: In the online documentation, view [What's New](#) to access quick links to topics for each of the new features in this Release; view [Documentation Downloads](#) to download all PDFs.

Table 1: Documentation Set for Gigamon Products

| GigaVUE TA Series 6.8 Hardware and Software Guides |
|---|
| <p>DID YOU KNOW? If you keep all PDFs for a release in common folder, you can easily search across the doc set by opening one of the files in Acrobat and choosing Edit > Advanced Search from the menu. This opens an interface that allows you to select a directory and search across all PDFs in a folder.</p> |
| <p>Hardware</p> <p>how to unpack, assemble, rackmount, connect, and initially configure ports the respective GigaVUE TA Series devices; reference information and specifications for the respective GigaVUE TA Series devices</p> |
| GigaVUE-HC1 Hardware Installation Guide |
| GigaVUE-HC3 Hardware Installation Guide |
| GigaVUE-HC1-Plus Hardware Installation Guide |
| GigaVUE-HCT Hardware Installation Guide |
| GigaVUE-TA25 Hardware Installation Guide |
| GigaVUE-TA25E Hardware Installation Guide |
| GigaVUE-TA100 Hardware Installation Guide |
| GigaVUE-TA200 Hardware Installation Guide |

GigaVUE TA Series 6.8 Hardware and Software Guides

GigaVUE-TA200E Hardware Installation Guide

GigaVUE-TA400 Hardware Installation Guide

GigaVUE-OS Installation Guide for DELL S4112F-ON

G-TAP A Series 2 Installation Guide

GigaVUE M Series Hardware Installation Guide

GigaVUE-FM Hardware Appliances Guide

Software Installation and Upgrade Guides

GigaVUE-FM Installation, Migration, and Upgrade Guide

GigaVUE-OS Upgrade Guide

GigaVUE V Series Migration Guide

Fabric Management and Administration Guides

GigaVUE Administration Guide

covers both GigaVUE-OS and GigaVUE-FM

GigaVUE Fabric Management Guide

how to install, deploy, and operate GigaVUE-FM; how to configure GigaSMART operations; covers both GigaVUE-FM and GigaVUE-OS features

Cloud Guides

how to configure the GigaVUE Cloud Suite components and set up traffic monitoring sessions for the cloud platforms

GigaVUE V Series Applications Guide

GigaVUE V Series Quick Start Guide

GigaVUE Cloud Suite Deployment Guide - AWS

GigaVUE Cloud Suite Deployment Guide - Azure

GigaVUE Cloud Suite Deployment Guide - OpenStack

GigaVUE Cloud Suite Deployment Guide - Nutanix

GigaVUE Cloud Suite Deployment Guide - VMware (ESXi)

GigaVUE Cloud Suite Deployment Guide - VMware (NSX-T)

GigaVUE Cloud Suite Deployment Guide - Third Party Orchestration

Universal Cloud TAP - Container Deployment Guide

Gigamon Containerized Broker Deployment Guide

| GigaVUE TA Series 6.8 Hardware and Software Guides | |
|--|---|
| GigaVUE Cloud Suite Deployment Guide - AWS Secret Regions | |
| GigaVUE Cloud Suite Deployment Guide - Azure Secret Regions | |
| Reference Guides | |
| GigaVUE-OS CLI Reference Guide | library of GigaVUE-OS CLI (Command Line Interface) commands used to configure and operate GigaVUE HC Series and GigaVUE TA Series devices |
| GigaVUE-OS Security Hardening Guide | |
| GigaVUE Firewall and Security Guide | |
| GigaVUE Licensing Guide | |
| GigaVUE-OS Cabling Quick Reference Guide | guidelines for the different types of cables used to connect Gigamon devices |
| GigaVUE-OS Compatibility and Interoperability Matrix | compatibility information and interoperability requirements for Gigamon devices |
| GigaVUE-FM REST API Reference in GigaVUE-FM User's Guide | samples uses of the GigaVUE-FM Application Program Interfaces (APIs) |
| Release Notes | |
| GigaVUE-OS, GigaVUE-FM, GigaVUE-VM, G-TAP A Series, and GigaVUE Cloud Suite Release Notes | new features, resolved issues, and known issues in this release ; important notes regarding installing and upgrading to this release |
| NOTE: | Release Notes are not included in the online documentation. |
| NOTE: | Registered Customers can log in to My Gigamon to download the Software and Release Notes from the Software and Docs page on to My Gigamon . Refer to How to Download Software and Release Notes from My Gigamon . |
| In-Product Help | |
| GigaVUE-FM Online Help | how to install, deploy, and operate GigaVUE-FM. |

How to Download Software and Release Notes from My Gigamon

Registered Customers can download software and corresponding Release Notes documents from the **Software & Release Notes** page on to [My Gigamon](#). Use the My Gigamon Software & Docs page to download:

- Gigamon Software installation and upgrade images,
- Release Notes for Gigamon Software, or
- Older versions of PDFs (pre-v5.7).

To download release-specific software, release notes, or older PDFs:

1. Log in to [My Gigamon](#).
2. Click on the **Software & Release Notes** link.
3. Use the **Product** and **Release** filters to find documentation for the current release. For example, select Product: "GigaVUE-FM" and Release: "5.6," enter "pdf" in the search box, and then click **GO** to view all PDF documentation for GigaVUE-FM 5.6.xx.

NOTE: My Gigamon is available to registered customers only. Newer documentation PDFs, with the exception of release notes, are all available through the publicly available online documentation.

Documentation Feedback

We are continuously improving our documentation to make it more accessible while maintaining accuracy and ease of use. Your feedback helps us to improve. To provide feedback and report issues in our documentation, send an email to: documentationfeedback@gigamon.com

Please provide the following information in the email to help us identify and resolve the issue. Copy and paste this form into your email, complete it as able, and send. We will respond as soon as possible.

| Documentation Feedback Form | | |
|-----------------------------|------------------------|---|
| About You | Your Name | |
| | Your Role | |
| | Your Company | |
| | | |
| For Online Topics | Online doc link | <i>(URL for where the issue is)</i> |
| | Topic Heading | <i>(if it's a long topic, please provide the heading of the section where the issue is)</i> |
| | | |

| | | |
|----------------------------|--|--|
| For PDF Topics | Document Title | <i>(shown on the cover page or in page header)</i> |
| | Product Version | <i>(shown on the cover page)</i> |
| | Document Version | <i>(shown on the cover page)</i> |
| | Chapter Heading | <i>(shown in footer)</i> |
| | PDF page # | <i>(shown in footer)</i> |
| How can we improve? | Describe the issue | <i>Describe the error or issue in the documentation. (If it helps, attach an image to show the issue.)</i> |
| | How can we improve the content? Be as specific as possible. | |
| | Any other comments? | |

Contact Technical Support

For information about Technical Support: Go to **Settings**  > **Support** > **Contact Support** in GigaVUE-FM.

You can also refer to <https://www.gigamon.com/support-and-services/contact-support> for Technical Support hours and contact information.

Email Technical Support at support@gigamon.com.

Contact Sales

Use the following information to Gigamon channel partner or Gigamon sales representatives.

Telephone: +1.408.831.4025

Sales: inside.sales@gigamon.com

Partners: www.gigamon.com/partners.html

Premium Support

Email Gigamon at inside.sales@gigamon.com for information on purchasing 24x7 Premium Support. Premium Support entitles you to round-the-clock phone support with a dedicated Support Engineer every day of the week.

The VÜE Community

The **VÜE Community** is a technical site where Gigamon users, partners, security and network professionals and Gigamon employees come together to share knowledge and expertise, ask questions, build their network and learn about best practices for Gigamon products.

Visit the VÜE Community site to:

- Find knowledge base articles and documentation
- Ask and answer questions and learn best practices from other members.
- Join special-interest groups to have focused collaboration around a technology, use-case, vertical market or beta release
- Take online learning lessons and tutorials to broaden your knowledge of Gigamon products.
- Open support tickets (Customers only)
- Download the latest product updates and documentation (Customers only)

The VÜE Community is a great way to get answers fast, learn from experts and collaborate directly with other members around your areas of interest.

Register today at community.gigamon.com

Questions? Contact our Community team at community@gigamon.com.

Glossary

D

decrypt list

need to decrypt (formerly blacklist)

decryptlist

need to decrypt - CLI Command (formerly blacklist)

drop list

selective forwarding - drop (formerly blacklist)

F

forward list

selective forwarding - forward (formerly whitelist)

L

leader

leader in clustering node relationship (formerly master)

M

member node

follower in clustering node relationship (formerly slave or non-master)

N

no-decrypt list

no need to decrypt (formerly whitelist)

nodecryptlist

no need to decrypt- CLI Command (formerly whitelist)

P

primary source

root timing; transmits sync info to clocks in its network segment (formerly grandmaster)

R

receiver

follower in a bidirectional clock relationship (formerly slave)

S

source

leader in a bidirectional clock relationship (formerly master)